



AI-TEK INSTRUMENTS, LLC

INSTRUCTION MANUAL

-FOR-

TACHPAK? 10 & 30

TACHTROL? 10 & 30





TACHTROL? plus

TACHLINK? WINDOWS / PC APPLICATION



TM5-500_B_5/23/07

1	Introduction	1
1.1	Overview	1
1.2	Tools	2
1.3	Notes and cautions	2
1.4	Where to go for help	3
2	Unpacking Instructions	3
2.1	Package contents	3
2.2	Unpacking	4
3	Mounting and Wiring Procedures	4
3.1	Installation and wiring guidelines	4
3.2	Mounting guidelines	6
3.2.1	TACHPAK 10, TACHPAK 30	6
3.2.2	TACHTROL 10, TACHTROL 30, TACHTROL plus	7
3.2.2.1	DIN Rail Mounting For TACHTROL 10, TACHTROL 30	8
	TACHTROL plus	
3.2.3	NEMA 4X Mounting for TACHTROL AND TACHPAK	9
3.2.4	Explosion Proof Mounting for TACHTROL (GRK type)	9
3.2.5	Explosion Proof Mounting for TACHPAK (EXB type)	10
3.2.6	Speed Sensor Mounting Considerations	11
3.2.6.1	Speed Sensor Types	11
3.2.6.1.1	Active Sensors	11
3.2.6.1.1.1	Single Channel	11
3.2.6.1.1.2	Dual Channel / Bi-Directional	11
3.2.6.1.2	Passive Sensors	11
3.3	Terminal Block assignments	12
3.3.1	TACHPAK 10, TACHPAK 30	12
3.3.2	TACHTROL 10, TACHTROL 30	15
3.3.3	TACHTROL plus	17

3.4	Wiring Connections	18
3.4.1	Speed Sensors	19
3.4.2	Power	20
3.4.3	External Verify and Relay Reset Circuit	21
3.5	USB (all TACHTROL and TACHPAK instruments)	22
3.5.1	Direct USB link	22
3.5.2	USB to RS-485 link (TACHTROL / TACHPAK 30 only)	22
3.6	RS-485 link (TACHTROL / TACHPAK 30 only)	23
3.6.1	Direct RS-485 link	23
3.6.2	RS-232 to RS-485 link	23
3.7	Using the Windows application	25
3.7.1	Loading TACHLINK onto Windows	25
4	Tachometer Functions	26
4.1	Programming the Tachometer	26
4.1.1	Basic Programming Rules	27
4.1.1.1	Exponential Notation	27
4.1.1.2	Number Line	28
4.1.2	Using the TACHTROL and TACHTROL^{plus} front panel	29
4.1.2.1	Function Keys	29
4.1.2.1.1	 (Function 1 key)	29
4.1.2.1.2	 (Function 2 key)	29
4.1.2.2	 Up/Down/Left/Right Arrow Keys	30
4.1.2.3	 Enter	30
4.1.2.4	Constant Types	30
4.2	Navigating Menus and Changing Constants	32
4.2.1	Main	32
4.2.1.1	Database Open and Database Save	34
4.2.1.2	Communication Port	35
4.2.1.3	About	36

4.2.2	Input / Digital Input Setup (Tachometer Mode)	37
4.2.2.1	Direction Detection.....	38
4.2.2.1.1	Quadrature.....	38
4.2.2.1.2	Direction Bit.....	39
4.2.2.2	Equation.....	40
4.2.2.3	Units (For Equation).....	41
4.2.2.4	Logic Low / High.....	42
4.2.2.5	Averaging and Average Period.....	43
4.2.2.6	Input Setup / Input A & B.....	45
4.2.2.6.1	Normalization.....	45
4.2.2.6.2	Units A & B.....	46
4.2.2.6.3	Input Type (A & B).....	47
4.2.2.6.4	Minimum Frequency / Maximum Period.....	47
4.2.3	Input / Digital Input Setup (Counter Mode)	48
4.2.3.1	Direction, Equation, Units.....	50
4.2.3.2	Logic Low, Logic High.....	51
4.2.3.3	Normalization (Input A & B).....	51
4.2.3.4	Units (Input A & B).....	51
4.2.3.5	Counter Type.....	52
4.2.3.6	Preset.....	52
4.2.4	Digital Output 1&2 (TP30 and TT30 Only)	53
	Relay Output 1&2 Setup (Tach and Counter Mode)	
4.2.4.1	Source.....	55
4.2.4.2	Hysteresis Definitions and Setpoint Classifications.....	55
4.2.4.2.1	Latch Function.....	56
4.2.4.2.2	Delay Function (On & Off).....	56
4.2.4.2.3	Failsafe Setpoint.....	58
4.2.4.2.4	Non-Failsafe Setpoint.....	59
4.2.4.3	Setpoint Categories.....	59
4.2.4.3.1	Overspeed Setpoint.....	59
4.2.4.3.2	Underspeed Setpoint.....	59

4.2.4.4	Output Switching / Setpoint Types	60
4.2.4.4.1	EA (Energize above setpoint)	61
4.2.4.4.2	EB (Energize below setpoint)	61
4.2.4.4.3	DA (De-energize above setpoint)	62
4.2.4.4.4	DB (De-energize below setpoint)	62
4.2.5	Analog Output (TP30 and TT30) Only	67
4.2.5.1	Analog Output Setup	67
4.2.5.1.1	Source	68
4.2.5.1.2	Range	69
4.2.5.1.3	Min / Max Value	69
4.2.5.2	Analog Output Calibration (TACHLINK ONLY)	70
4.2.6	Security	72
4.2.6.1	Alarm Reset	73
4.2.6.1.1	Tachometer Mode Alarm Reset	73
4.2.6.1.2	Counter Mode Alarm Reset	74
4.2.6.2	Alarm Hold-Off	75
4.2.6.3	Keypad/Keyboard Lock	77
4.2.6.3.1	Keypad Lock	77
4.2.6.3.2	Keyboard Lock	77
4.2.6.4	Display Address	78
4.2.6.5	Security Code	78
4.2.6.5.1	Creating / Changing a Security Code	79
4.2.6.5.2	Entering a Security Code	80
4.2.7	Verify	82
4.2.8	Diagnostics	85
4.2.9	Plotting (TACHLINK Only)	87
4.2.9.1	Plotting Setup	87
4.2.9.2	Plotting Output	89

4.2.9.2.1	Plotting Toolbar	91
	• Tracking Resume:	91
	• Tracking Pause:	91
	• Axes Scroll:	91
	• Axes Zoom:	91
	• Zoom Out / In:	91
	• Select:	92
	• Zoom Box:	92
	• Data Cursor:	92
	• Edit:	93
	• Copy To Clipboard:	93
	• Save:	93
	• Print/Print Preview:	93
4.2.10	Display (TACHTROL series only)	94
4.2.10.1	Display/Keypad Setup	95
4.2.10.1.1	Display Line 1 & 2	95
4.2.10.1.2	Backlight Timeout	95
4.2.10.1.3	Contrast	96
4.3	Infrared Remote	96
5	Example Applications	97
5.1	Basic setup	97
5.1.1	Material Requirements	97
5.1.2	Connections	97
5.1.3	TACHPAK 10 Programming & Setup (rpm)	98
	<u>Input Setup</u>	98
5.1.3.1	Tachometer Mode	98
5.1.3.2	Direction	98
5.1.3.3	Equation & Units	98
5.1.3.4	Logic Low & High	98
5.1.3.5	Averaging	98

5.1.3.6	Normalization	98
5.1.3.7	Units	99
5.1.3.8	Input Type	99
5.1.3.9	Min Freq.....	99
	<u>Relay Output 1 Setup</u>	99
5.1.3.10	Source	99
5.1.3.11	Latch Mode	99
5.1.3.12	On / Off Delay	99
5.1.3.13	Output Switching	99
	<u>Digital 1 &2, Relay 2 and Analog Output</u>	99
	<u>Security Setup</u>	99
5.1.3.14	Alarm Hold-Off	99
5.1.3.15	Keyboard Lock	99
5.1.3.16	Change Security Code	99
5.1.4	Use Verify to validate setup	100
5.2	Intermediate setup	100
5.2.1	Material Requirements.....	100
5.2.2	Connections.....	100
5.2.3	TACHTROL 30 Programming & Setup (Speed).....	101
	<u>Input Setup</u>	101
5.2.3.1	Tachometer Mode	101
5.2.3.2	Direction	101
5.2.3.3	Equation & Units	101
5.2.3.4	Logic Low & High	101
5.2.3.5	Averaging	101
5.2.3.6	Normalization	101
5.2.3.7	Units	101
5.2.3.8	Input Type	102
5.2.3.9	Min Freq	102
	<u>Digital Output 1 Setup (Over speed alarm)</u>	102
5.2.3.10	Source	102

5.2.3.11	Latch Mode	102
5.2.3.12	On / Off Delay	102
5.2.3.13	Output Switching	102
	<u>Digital Output 2 Setup</u>	102
5.2.3.14	Output Switching	102
	<u>Relay Output 1 Setup (Failsafe Overspeed alarm)</u>	102
5.2.3.15	Source	102
5.2.3.16	Latch Mode	102
5.2.3.17	On / Off Delay	103
5.2.3.18	Output Switching	103
	<u>Relay Output 2 Setup (Failsafe Underspeed alarm)</u>	103
5.2.3.19	Output Switching	103
	<u>Analog Output Setup</u>	103
5.2.3.20	Source	103
5.2.3.21	Range	103
5.2.3.22	Min / Max Value	103
	<u>Security Setup</u>	104
5.2.3.23	Alarm Hold-Off	104
5.2.3.24	Keypad Lock	104
5.2.3.25	Display Address	104
5.2.3.26	Change Security Code	104
	<u>Display Setup</u>	104
5.2.3.27	Display Line 1 & 2	104
5.2.3.28	Backlight Timeout	104
5.2.3.29	Contrast	104
5.2.4	Use Verify to validate setup	104
5.3	Advanced Setup	105
5.3.1	Problem Description	105
5.3.2	Material Requirements	106
5.3.3	Connections	106
5.3.4	TACHTROL 10 Programming & Setup (Displacement)	106

	<u>Input Setup</u>	107
5.3.4.1	Counter Mode	107
5.3.4.2	Direction	107
5.3.4.3	Equation & Units	107
5.3.4.4	Logic Low & High	107
5.3.4.5	Normalization	107
5.3.4.6	Units	107
5.3.4.7	Counter Type	107
5.3.4.8	Preset	108
	<u>Relay Output 1 Setup</u>	108
5.3.4.9	Source	108
5.3.4.10	Latch Mode	108
5.3.4.11	On / Off Delay	108
5.3.4.12	Output Switching	108
	<u>Relay Output 2 Setup</u>	108
5.3.4.13	Output Switching	108
	<u>Digital Output 1 & 2 and Analog Output Setup</u>	108
	<u>Security Setup</u>	108
5.3.4.14	Alarm Hold-Off	108
5.3.4.15	Keypad Lock	108
5.3.4.16	Display Address	109
5.3.4.17	Change Security Code	109
	<u>Display Setup</u>	109
5.3.4.18	Display Line 1 & 2	109
5.3.4.19	Backlight Timeout	109
5.3.4.20	Contrast	109
5.3.5	TACHTROL 30 Programming & Setup (Speed).....	109
	<u>Input Setup</u>	109
5.3.5.1	Tachometer Mode	109
5.3.5.2	Direction	109
5.3.5.3	Equation & Units	110

5.3.5.4	Logic Low & High	110
5.3.5.5	Averaging	110
5.3.5.6	Normalization	110
5.3.5.7	Units	110
5.3.5.8	Input Type	110
5.3.5.9	Min Freq	110
	<u>Digital Output 1 Setup</u>	111
5.3.5.10	Source	111
5.3.5.11	Latch Mode	111
5.3.5.12	On / Off Delay	111
5.3.5.13	Output Switching	111
	<u>Digital Output 2 Setup</u>	111
5.3.5.14	Output Switching	111
	<u>Relay Output 1 & 2</u>	111
	<u>Analog Output Setup</u>	111
5.3.5.15	Source	111
5.3.5.16	Range	112
5.3.5.17	Min / Max Value	112
	<u>Security Setup</u>	112
5.3.5.18	Alarm Hold-Off	112
5.3.5.19	Keypad Lock	112
5.3.5.20	Display Address	112
5.3.5.21	Change Security Code	112
	<u>Display Setup</u>	112
5.3.5.22	Display Line 1 & 2	112
5.3.5.23	Backlight Timeout	112
5.3.5.24	Contrast	112
5.3.6	Use Verify to validate setup	112

6 Specifications 113

Electrical

Input Power 113

Power consumption, DC Voltage, AC Voltage, Power Sharing, Output Power

Input Signal Characteristics 113

Channel A & B, Frequency, Input Impedance, Input Sensitivity, Common Mode Rejection Ratio, Electrical Isolation

Verify and Reset 114

Frequency, Input Impedance, Input Sensitivity, Common Mode Rejection Ratio, Electrical Isolation

Direction 114

Frequency, Input Impedance, Input Sensitivity, Common Mode Rejection Ratio, Electrical Isolation

Output Characteristics

Relays (Mechanical) 115

Physical, Contact Rating, Response Time (operates and release), Electrical Isolation, Switch point Accuracy

Relays (Solid State) 115

Physical, Contact Rating, Response Time (operate and release), Electrical Isolation, Switchpoint Accuracy

Analog Output 116

Ranges, Accuracy, Resolution, Linearity, Loop Impedance, Response Time, Electrical Isolation

Display (applies to both remote and integrated displays) 116

Resolution, Accuracy, Communication Protocol, Network, Electrical Isolation

Utility RS485 117

Communication Protocol, Maximum Transmission Distance, Electrical Isolation

USB 117

Processing Platform 117

Clock Speed, Acquisition Time, Accuracy, Resolution

Environmental	118
Operating Temperature, Thermal Cycle, Dielectric Strength, Humidity, Vibration, Shock, EMC, RoHS	
Connectors	118
USB, RS485, Remote Display, Signal And Power I/O	
7 Target Variable Conversions	119
8 Annex 1: Startup Databases	120
9 Warranty and Return Shipments Statement	121

- Drives up to 8 remote displays (TTplus). A single display can be up to 1000 ft away with a simple RJ11 (phone jack) connection. Longer runs, cable type and number of displays will affect distance.
- Security mode protects unauthorized access for programming or alarm resets (through display or GUI)
- Mounts to DIN rail. Power can be applied through special DIN bus when used with AI-TEK power supply (TP only).
- Environmentally hardened for temperature, vibration and shock. EMC / CE compliant to current BS EN directives.
- Integrated display capable of two independent output channels for speed, count period or equation results, Alarm status / security, Mode, User defined units for each channel, 128x64 LCD graphics display with backlight.
 - (TT only)
- Designed and manufactured compliant with RoHS.

1.2. Tools

No special tools are required to perform the procedures in this manual. A flat blade screwdriver is required for making connections; 1/8" (3.2mm) wide for TACHPAK and 3/32" (2.4mm) for TACHTROL.

1.3. Notes and cautions

This Manual uses the following conventions to emphasize important information.



Note: Provides an explanation or amplification



Caution: Advises there is risk of damaging equipment if directions are not followed.



Danger: Advises there is risk to personal health if directions are not followed.

1.4. Where to go for help

For technical support and programming assistance on this product, please contact your local distributor. To locate a distributor, please use one of the following:

Phone: 1-800-643-0643

website: www.aitekinstruments.com/distributors/

2. Unpacking Instructions

To ensure safe transit, every TACHPAK and TACHTROL is thoroughly tested and carefully packed prior to leaving the plant. Responsibility for its safe delivery was assumed by the carrier upon acceptance of the shipment. Claims for loss or damage sustained in transit must be made with the carrier.

2.1. Package contents

TACHPAK 10 & 30 and TACHTROL 10 & 30 are shipped in a single carton containing one instrument, TACHLINK and a manual on CD ROM, and a USB cable.

TACHTROL^{plus} shipped in a single carton containing one instrument and a display cable with RJ-11 terminations.

TACHLINK PC application for Windows 2000 and XP. Shipped in a single carton containing a CD and 10ft USB cable.

TACHTROL 10 & 30 and TACHTROL^{plus} Explosion Proof and NEMA 4X are shipped in a single carton containing one boxed instrument as described above, one Infrared remote and one DIN rail mounting kit.

TACHPAK 10 & 30 Explosion Proof and NEMA 4X are shipped in a single carton containing one rated enclosure and one boxed instrument as described above.

2.2. Unpacking



Caution! : TACHPAK and TACHTROL are precision instruments. Although they are designed to withstand the rigors of industrial use, excessive physical shock or vibration can cause damage. Handle carefully. Do not drop or subject to physical extremes.

1. Place the carton on a level surface in a well-lighted area and open the top.
2. Carefully lift out the instrument and separate from any extraneous packing material.
3. Remove all instrument related materials
4. Inspect for damage

3. Mounting and Wiring Procedures

3.1. Installation and wiring guidelines

- Locate instrument away from sources of water, heat, humidity, and dust or provide a suitable enclosure to protect it from these elements.
- Locate the instrument away from sources of electrical noise such as , but not limited to: SCRs, triacs, buzzers, horns, motors, welding equipment, contactors, heavy current relays, and other noise generating electrical equipment.
- Use a grounded metal enclosure to protect the instrument from radiated electrical noise and other magnetic influences.
- Separate low voltage signal and control wiring from switching and power wiring. Plan cabinet and panel wiring so that power and relay wiring are dressed to one side and low-level signals are dressed to the other. Plan wiring to maintain separation at entry to, and egress from the enclosure.

- Signal and control wiring should be, at a minimum, in twisted pairs. Lines for magnetic pick-ups and other frequency output devices should be run in separate shielded cables.
- Try not to use commutators or slip rings to transmit low-level signals. Should this be absolutely necessary, ensure that the point of contact is maintained and clean at all times. Refer questions about this type of application to your local distributor.
- Connect the drain from shielded cables so that no current flows in the shielded cable by first connecting all shield segments in series, then to the appropriate connection on the tachometer or to an approved earth ground nearest the instrument.
- Provide a power source that is free of electrical noise and power interruption. Use either the available AI-TEK DC power supply or one that can operate within the limits of the instruments specifications. Battery chargers should be avoided unless isolation can be provided between the tachometer and charger system.

3.2. Mounting guidelines

3.2.1. TACHPAK 10, TACHPAK 30

TACHPAK is designed to mount to 35 mm DIN rail. Locate TACHPAK to ensure it is adequately protected from the environment and ensure mounting is secure.

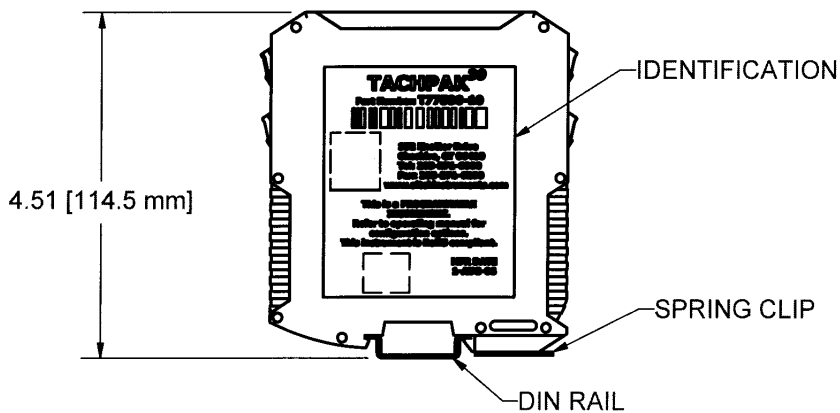
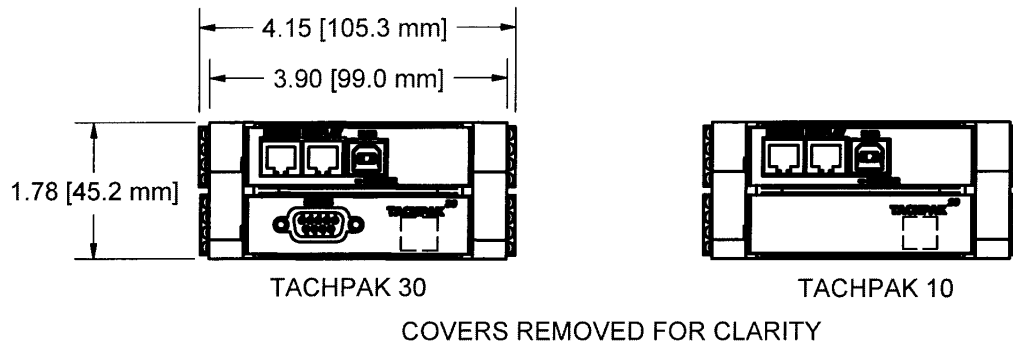

3.2.2. TACHTROL 10, TACHTROL 30, TACHTROL plus

TACHTROL is designed to mount into a panel with a wide range of thickness. Locate TACHTROL to ensure it is adequately protected from the environment and ensure mounting is secure.

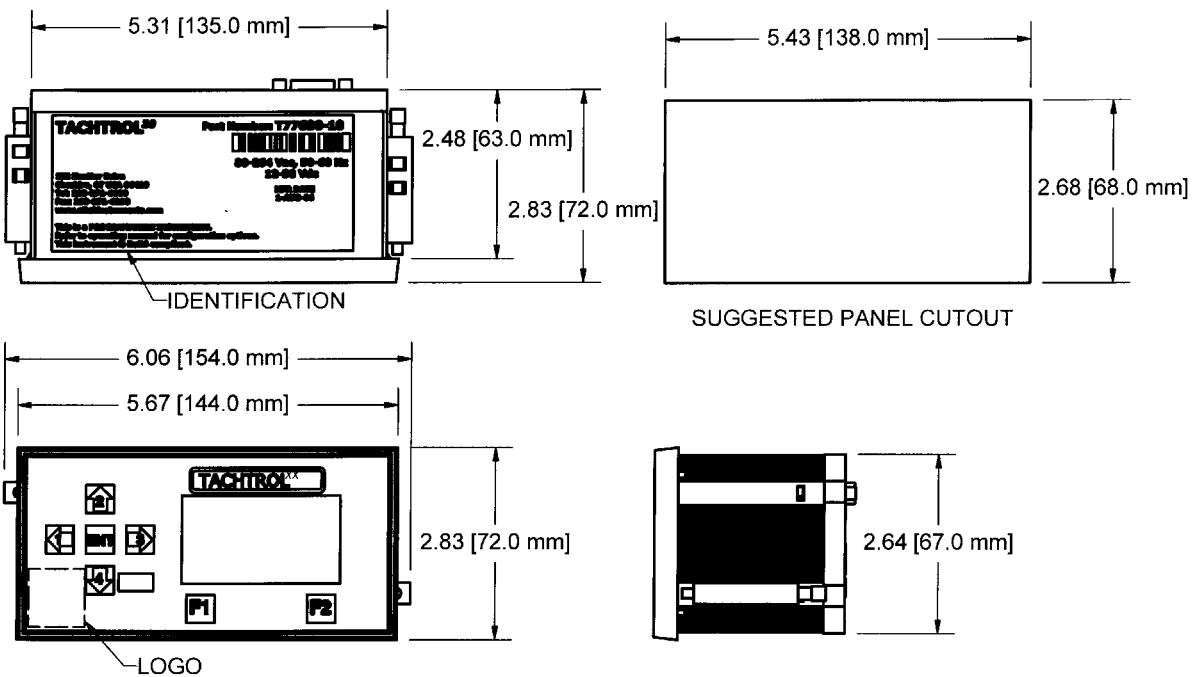

**3.2.2.1. DIN Rail Mounting For TACHTROL 10,
TACHTROL 30, TACHTROL plus**

A mounting kit is available to allow TACHTROL to be mounted to 35 mm DIN rail.

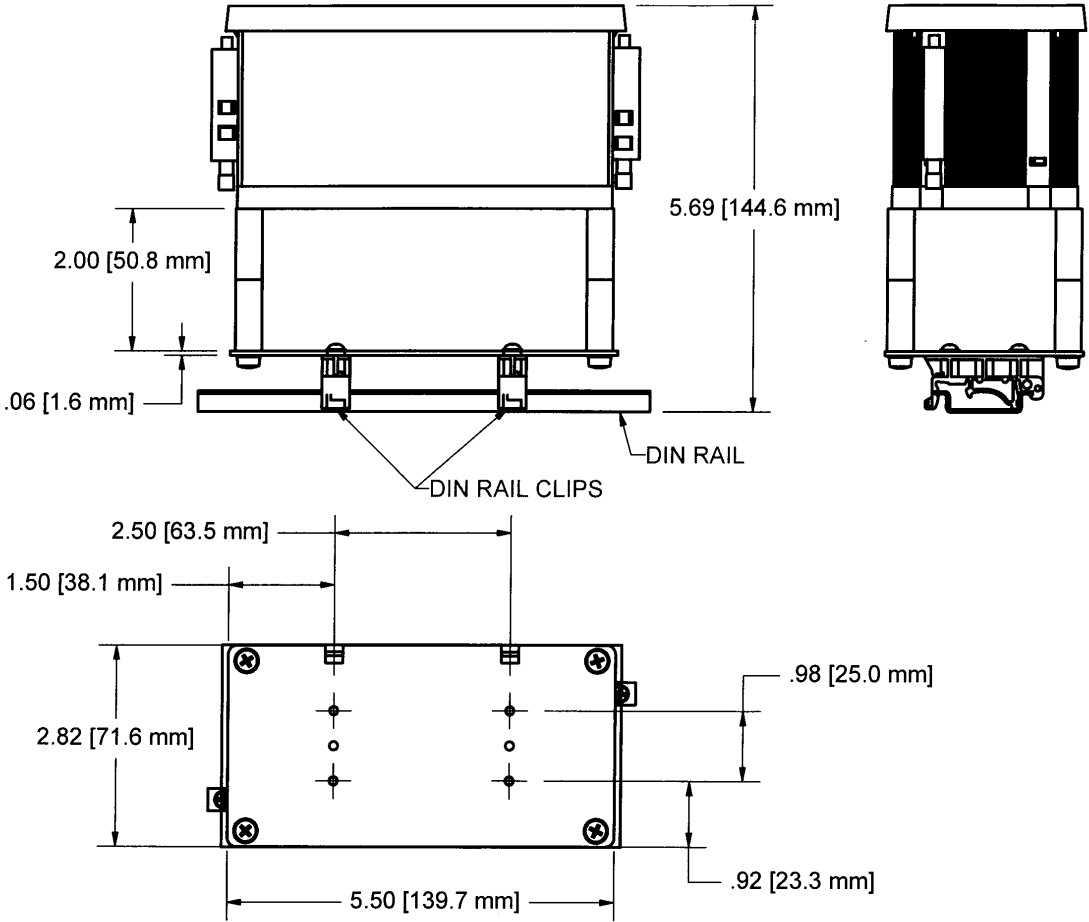

3.2.3. NEMA 4X Mounting For TACHTROL AND TACHPAK

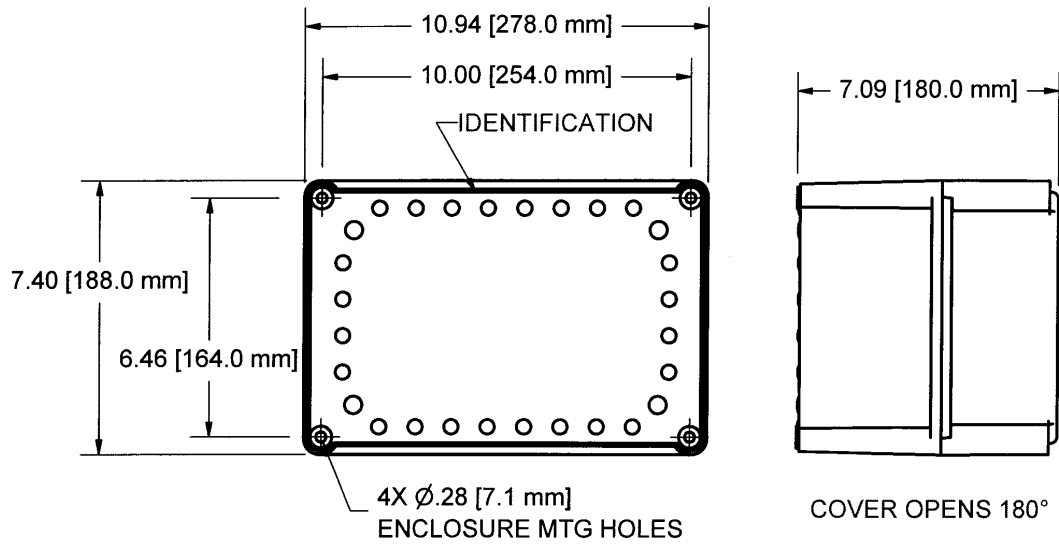

3.2.4. Explosion Proof Mounting For TACHTROL (EXB type)

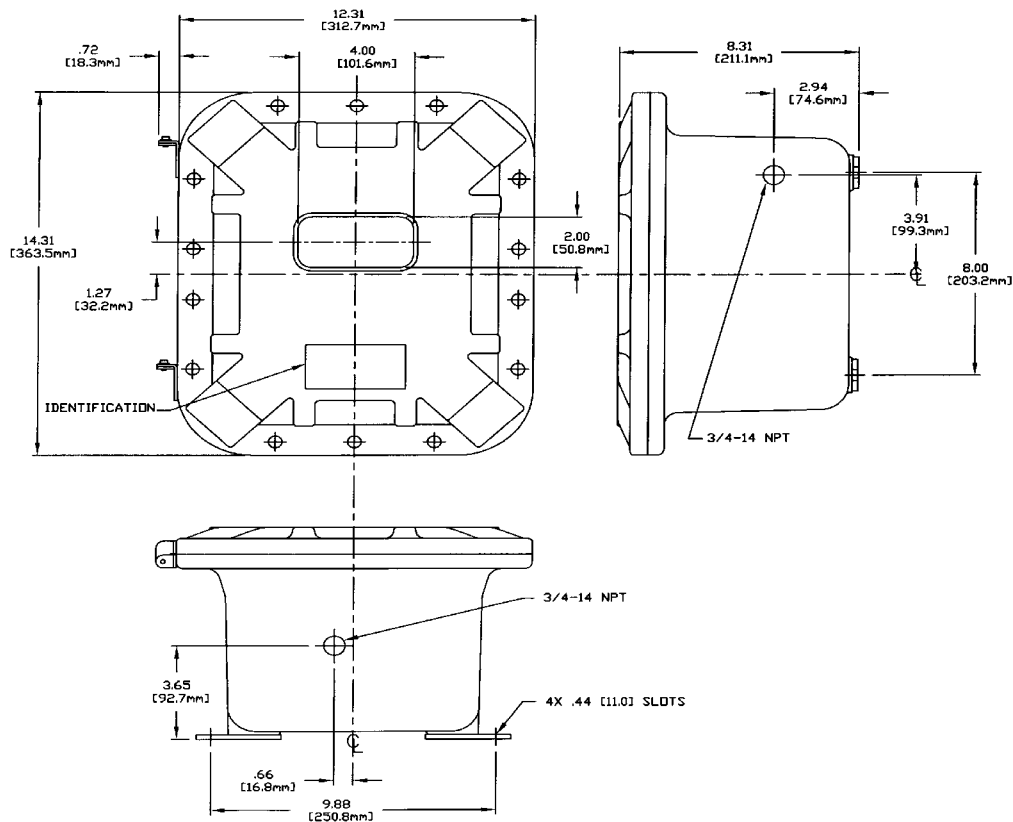

3.2.5. Explosion Proof Mounting For TACHPAK (GRK type)

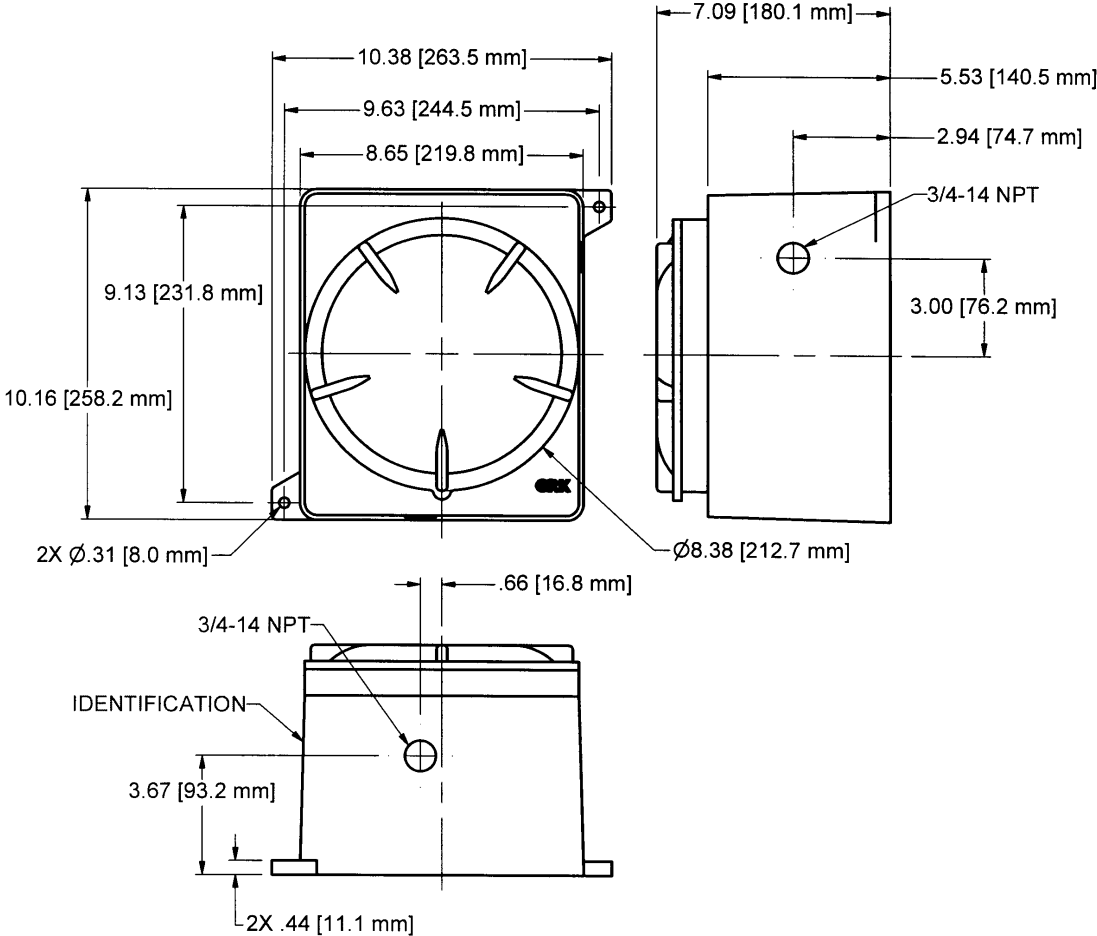

3.2.6. Speed Sensor Mounting Considerations

The sensor should be secured in a rigid mount. Normal machine vibration should not affect the accuracy of the instrument. However, any relative motion, caused by a loose sensor or vibrating mount between the sensor and the target can produce erratic behavior. Consult the applicable AI-TEK Instruments, LLC product specifications.

3.2.6.1. Speed Sensor Types

AI-TEK offers a wide variety of speed sensors that are compatible with the tachometer instruments. There are also other sources of speed sensors that are compatible with AI-TEK tachometers.

3.2.6.1.1. Active Sensors

Active sensors require power to operate and the output is usually a digital square-wave. They are necessary for low and zero speed applications. Sensing technologies are typically Hall effect but also may be Magneto Resistive.

3.2.6.1.1.1. Single Channel

Usually 3 wires for connection; power, ground and digital signal output.

3.2.6.1.1.2. Dual Channel / Bi-Directional

Usually 5 wires for connection; power, ground, two digital signal outputs and direction logic. These sensors can determine speed and direction of a rotating target.

3.2.6.1.2. Passive Sensors

Passive sensors require no external power to operate. Power is generated internally during operation. Typically one output only with two signal wires for connection.

3.3. Terminal Block assignments

3.3.1. TACHPAK 10, TACHPAK 30

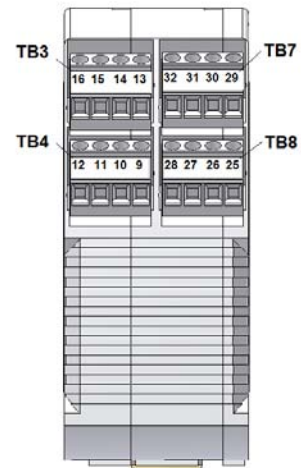
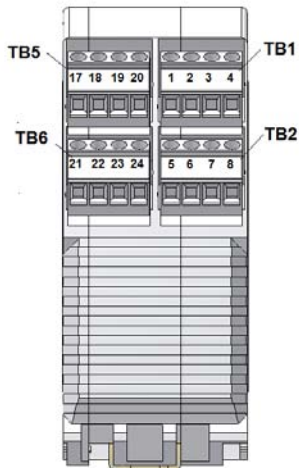
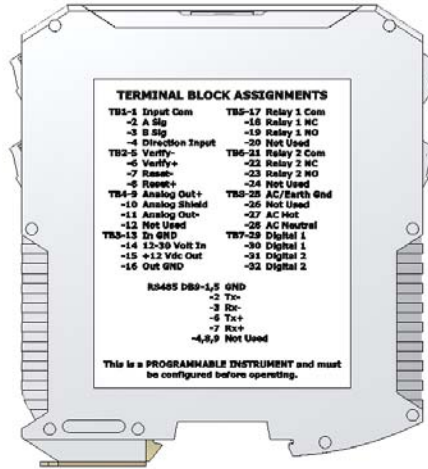

Terminal block assignments are shown below.

Terminal Block	Pin #	TACHPAK 30	TACHPAK 10
TB1	1	Input Com	Input Com
	2	A Sig	A Sig
	3	B Sig	B Sig
	4	Direction Input	Direction Input
TB2	5	Verify -	Verify -
	6	Verify +	Verify +
	7	Reset -	Reset -
	8	Reset +	Reset +
TB4	9	Analog Out +	Not Available
	10	Analog Shield	
	11	Analog Out -	
	12	Not Used	
TB3	13	In GND	In GND
	14	12-30 Volt In	12-30 Volt In
	15	+12 Vdc Out	+12 Vdc Out
	16	Out GND	Out GND
TB5	17	Relay 1 Com	Relay 1 Com
	18	Relay 1 N.C.	Relay 1 N.C.
	19	Relay 1 N.O.	Relay 1 N.O.
	20	Not Used	Not Used
TB6	21	Relay 2 Com	Relay 2 Com
	22	Relay 2 N.C.	Relay 2 N.C.
	23	Relay 2 N.O.	Relay 2 N.O.
	24	Not Used	Not Used
TB8	25	AC/Earth Gnd	AC/Earth Gnd
	26	Not Used	Not Used
	27	AC Hot	AC Hot
	28	AC Neutral	AC Neutral
TB7	29	Digital 1 (no polarity)	Not Available
	30	Digital 1 (no polarity)	
	31	Digital 2 (no polarity)	
	32	Digital 2 (no polarity)	

Connection to 12-30 Volt In (TB3-14) and In GND (TB3-14) is also available on the bottom of TACHPAK 10 & 30. A special DIN rail power bus adaptor is available as an accessory and works with the accessory power supply.



In high noise applications, connect unused inputs to ground through a 1kΩ resistor.

TACHPAK has additional connections that can be made for Remote Displays, USB and RS485. When mounting, ensure sufficient clearance for cabling.

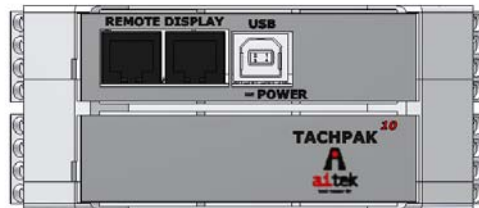
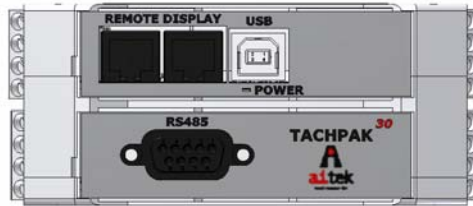

Terminal Block	Pin #	TACHPAK 30	TACHPAK 10
Remote Display		Use RJ11 type connector. No individual breakout of pins.	
USB		Use USB "B" type connector. No individual breakout of pins.	
RS485 DB9	1,5	GND	Not Available
	2	Tx -	
	3	Rx -	
	6	Tx +	
	7	Rx +	
	4,8,9	Not Used	



Remember to select the applicable Comm. connection per section 4.2.1.2

3.3.2. TACHTROL 10, TACHTROL 30

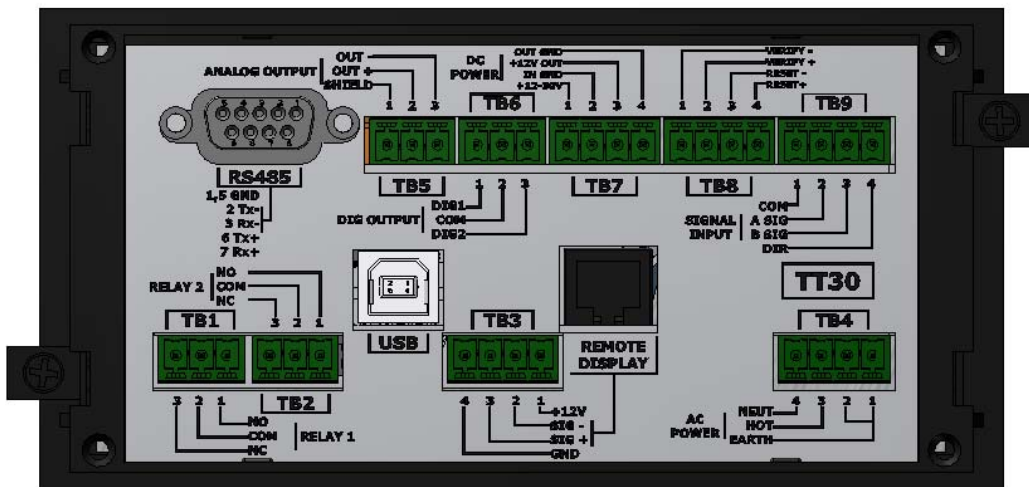
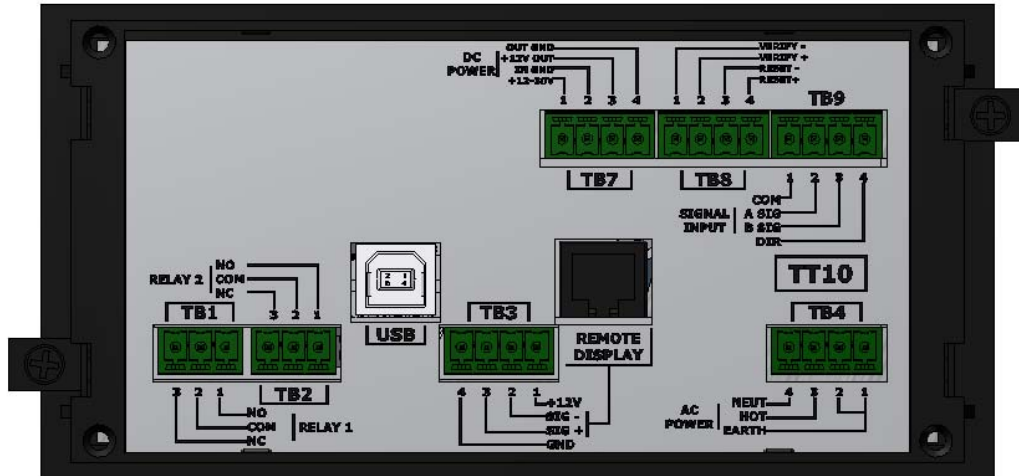

Terminal block assignments are shown below.

Terminal Block	Pin #	TACHTROL 30	TACHTROL 10
TB1	1	Relay 1 N.O.	Relay 1 N.O.
	2	Relay 1 Com	Relay 1 Com
	3	Relay 1 N.C.	Relay 1 N.C.
TB2	1	Relay 2 N.O.	Relay 2 N.O.
	2	Relay 2 Com	Relay 2 Com
	3	Relay 2 N.C.	Relay 2 N.C.
TB3 Remote Display	1	+12vdc Out	+12vdc Out
	2	Sig -	Sig -
	3	Sig +	Sig +
	4	Gnd	Gnd
TB4	1	AC/Earth Gnd	AC/Earth Gnd
	2	AC/Earth Gnd	AC/Earth Gnd
	3	AC Hot	AC Hot
	4	AC Neutral	AC Neutral
TB5	1	Analog Shield	Not Available
	2	Analog Out +	
	3	Analog Out -	
TB6	1	Digital 1	Not Available
	2	Dig Com	
	3	Digital 2	
TB7	1	12-30 Volt In	12-30 Volt In
	2	In GND	In GND
	3	+12 Vdc Out	+12 Vdc Out
	4	Out GND	Out GND
TB8	1	Verify -	Verify -
	2	Verify +	Verify +
	3	Reset -	Reset -
	4	Reset +	Reset +
TB9	1	Input Com	Input Com
	2	A Sig	A Sig
	3	B Sig	B Sig
	4	Direction Input	Direction Input



In high noise applications, connect unused inputs to ground through a 1kΩ resistor.

TACHTROL has additional connections that can be made for Remote Displays, USB and RS485. When mounting, ensure sufficient clearance for cabling.

Terminal Block	Pin #	TACHTROL 30	TACHTROL 10
Remote Display	Use RJ11 type connector. See TB3 for individual breakout of pins.		
USB	Use USB "B" type connector. No individual breakout of pins.		
RS485 DB9	1,5	GND	Not Available
	2	Tx -	
	3	Rx -	
	6	Tx +	
	7	Rx +	
	4,8,9	Not Used	



Remember to select the applicable Comm. connection per section 4.2.1.2

3.3.3. TACHTROL plus

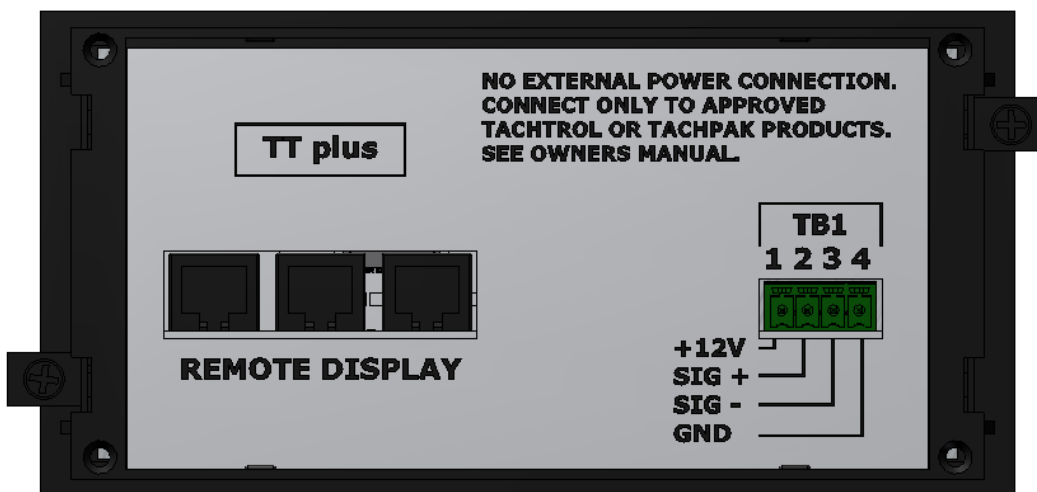

Terminal Block	Pin #	TACHTROL ^{plus}
TB1 Remote Display	1	+12vdc In
	2	Sig +
	3	Sig -
	4	Gnd
Remote Display	Use RJ11 type connector. See TB1 for individual breakout of pins.	



TACHTROL^{plus} can be connected to TACHTROL or TACHPAK using high quality RJ11 connectors and cables. If longer distances or more durable connections are required, TACHTROL and TACHTROL^{plus} can be connected with larger gauge cables via TB3 and TB1 respectively. Display connections to TACHPAK can also be upgraded. Simply run a short RJ11 cable to a terminal block and continue the run with larger gauge cable. When connecting multiple displays, ensure sufficient power is available to the base tachometer unit (see section 6). If it is necessary to run on 12volts dc, the supply should be capable of at least 1.5 amps. Also, limit the total number of remote displays to 3.



See Specifications, Section 6 for detailed wiring and parametric electrical information.

3.4.Wiring Connections

3.4.1. Speed Sensors

	TACHTROL 10 & 30		TACHPAK 10 & 30	
Sensor Type/Connection	Terminal	Description	Terminal	Description
Passive				
Wire 1	TB9, pin 2 <u>or</u> 3	A Sig <u>or</u> B Sig	TB1, pin 2 <u>or</u> 3	A Sig <u>or</u> B Sig
Wire 2	TB9, pin 1	Input Com	TB1, pin 1	Input Com
Cable Shield	TB4, pin 1 <u>or</u> 2	AC Earth Gnd	TB8, pin 25	AC Earth Gnd
Active (single channel)				
Power	TB7, pin 3 *	+12 Vdc Out	TB3, pin 15 *	+12 Vdc Out
Ground{	{ TB7, pin 4*	Out GND	TB3, pin 16 *	Out GND
	-common with-	-common with-	-common with-	-common with-
{	TB9, pin 1	Input Com	TB1, pin 1	Input Com
Output	TB9, pin 2 <u>or</u> 3	A Sig <u>or</u> B Sig	TB1, pin 2 <u>or</u> 3	A Sig <u>or</u> B Sig
Cable Shield	TB4, pin 1 <u>or</u> 2	AC Earth Gnd	TB8, pin 25	AC Earth Gnd
Active (dual channel)				
Power	TB7, pin 3 *	+12 Vdc Out	TB3, pin 15 *	+12 Vdc Out
Ground{	{ TB7, pin 4*	Out GND	TB3, pin 16 *	Out GND
	-common with-	-common with-	-common with-	-common with-
{	TB9, pin 1	Input Com	TB1, pin 1	Input Com
Output 1 (A)	TB9, pin 2	A Sig	TB1, pin 2	A Sig
Output 2 (B)	TB9, pin 3	B Sig	TB1, pin 3	B Sig
Direction	TB9, pin 4	Direction Input	TB1, pin 4	Direction Input
Cable Shield	TB4, pin 1 <u>or</u> 2	AC Earth Gnd	TB8, pin 25	AC Earth Gnd

***Can use external or internal power supply. Ensure all power and signal common connections are electrically tied together.**

3.4.2. Power

	TACHTROL 10 & 30		TACHPAK 10 & 30	
Power Type	Terminal	Description	Terminal	Description
DC	Positive (+)	TB7, pin 1	TB3, pin 14	12-30 Volt In
	Negative (-)	TB7, pin 2**	TB3, pin 13**	In GND
AC	Hot	TB4, pin 3	TB8, pin 27	AC Hot
	Neutral	TB4, pin 4	TB8, pin 28	AC Neutral
	Earth	TB4, pin 1 <u>or</u> 2	TB8, pin 25	AC Earth Gnd
DC & AC	Both can be connected simultaneously			

**** Ensure all power and signal common connections are electrically tied together.**



When using external power supplies to power either the tachometer or sensor, ensure that all ground connections are common. Be careful not to create ground loops. Bad grounds and ground loops can cause erratic behavior in any electronic device.

3.4.3. External Verify and Relay Reset Circuit

External Function	TACHTROL 10 & 30		TACHPAK 10 & 30	
	Terminal	Description	Terminal	Description
Verify * 3.5 – 30 Vdc > switch > >>>>>>>>> Ground >	TB8, pin 2	Verify +	TB2, pin 6	Verify +
	TB8, pin 1	Verify -	TB2, pin 5	Verify –
Reset * 3.5 – 30 Vdc > switch > >>>>>>>>> Ground >	TB8, pin 4	Reset +	TB2, pin 8	Reset +
	TB8, pin 3	Reset –	TB2, pin 7	Reset –

***Can use external or internal power supply. Ensure all power and signal common connections are electrically tied together.**

3.5.USB (all TACHTROL and TACHPAK instruments)

USB is the simplest way to connect a computer to TACHTROL or TACHPAK. When TACHLINK is loaded onto a pc it allows full access to programming and viewing tachometer functions and outputs. There are 2 popular methods of connection.

3.5.1. Direct USB link

Use a high quality USB 2.0 A/B cable. Maximum transmission distance is approximately 10 to 15 ft. USB booster / distance extenders are available that allow distances up to approximately 150 ft. Connect the “A” (larger) end to your computer and the “B” (smaller) end to the tachometer. See section 3.0 for installation instructions prior to connecting.



When connecting, one at a time, to multiple tachometers, the system may request the TACHLINK installation disk be re-inserted to re-install certain files.

3.5.2. USB to RS-485 link (TACHTROL / TACHPAK 30 only)

Some computers do not have a serial port available to connect the RS-485. A second method to utilize the USB connection on the computer is to use a RS-485 to USB converter such as the B&B electronics model USOTL4 or equivalent. This device is port powered and provides electrical isolation between tachometer and computer. Make connections as defined below or follow manufacturers instructions.

USOTL4	TACHTROL/TACHPAK 30	
Designation	Designation	Pin
GND	GND	1 or 5
RDA-	Tx -	2
TDA -	Rx -	3
RDB+	Tx +	6
TDB+	Rx +	7
N/A	Not Used	4,8,9

Set Dip Switches and install any necessary drivers for converter device as directed by manufacturers instructions. Windows will configure the converter as an additional COM port.

3.6. RS-485 link (TACHTROL / TACHPAK 30 only)

RS-485 allows full TACHLINK function and the ability to communicate over thousands of feet. Typically, the need to reload files from the installation disk is eliminated when connecting, one at a time, to multiple tachometers.

3.6.1. Direct RS-485 link

This method is the most direct but requires installation of a RS-485 card into the computer. Many are available commercially such as the B&B electronics model 3PCI0U1 or equivalent. It is recommended to use a card that provides electrical isolation between computer and tachometer. Make connections as defined below or follow manufacturers instructions. Set Dip Switches and install any necessary drivers for converter device as directed by manufacturers instructions.

3PCI0U1		TACHTROL/TACHPAK 30	
Designation	Pin	Designation	Pin
GND	5	GND	1 or 5
RD-	1	Tx -	2
TD -	3	Rx -	3
RD+	9	Tx +	6
TD+	2	Rx +	7
N/A	N/A	Not Used	4,8,9

3.6.2. RS-232 to RS-485 link

Many computers, especially laptops, have either RS-232 or USB connections and there may be no room to install a RS-485 card. An external converter such as the B&B electronics model 4WSD9TB or equivalent allows the connection of the

tachometer in such situations. Make connections as defined below or follow manufacturers instructions. Set Dip Switches and install any necessary drivers for converter device as directed by manufacturers instructions.

4WSD9TB	TACHTROL/TACHPAK 30	
Designation	Designation	Pin
GND	GND	1 or 5
RDA-	Tx -	2
TDA -	Rx -	3
RDB+	Tx +	6
TDB+	Rx +	7
N/A	Not Used	4,8,9

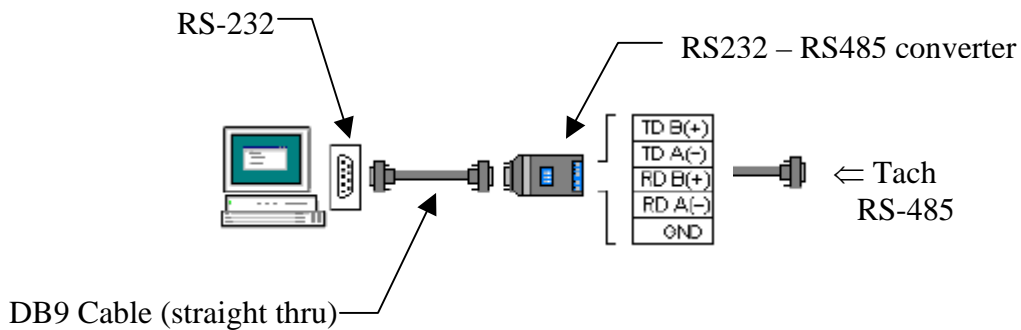

Remember to select the applicable Comm. connection per section 4.2.1.2

3.7. Using the Windows Application

3.7.1. Loading TACHLINK Onto Windows 2000 or XP.

- Load onto your pc prior to connecting with either USB or RS485. Close all unnecessary applications.
- Once inserted, the CD should automatically load the installation. If not, click **START** then **RUN**. Type “X:\Setup.exe” (replace “X” with the correct drive letter for the applicable CD-ROM drive, typically D). Follow the on-screen instructions to complete the installation.
- If your pc does not have Microsoft ® .NET 1.1 Framework, it will install first. Follow the on-screen instructions to complete the installation. When complete, restart the computer and log in if necessary. TACHLINK will now install. Follow the on-screen instructions.
- When complete AI-TEK TACHLINK and manual icon will appear on your desktop. All starter databases are loaded.
- Connect power to tachometer, then connect USB.
- **Found New Hardware Wizard** will start:
 - Select **NO** if asked to allow connection to Windows Update. > Click **NEXT**
 - Insert Installation /Disk > Select **Install Automatically** > Click **NEXT**
 - If **Logo Compatibility** notice appears, select **Continue Anyway**.
 - System should find USB driver file. If not, the following dialog box will appear:
[Insert the CD labeled “FTDI FTD2XX Drivers Disk” into your CD ROM]
 - Insert CD > Click **OK**
 - System should find USB driver file. If not, the following dialog box will appear:
[The file’FTD2XX.sys’ on FTDI FTD2XX Drivers Disk is needed]
 - Click **BROWSE** > X:\program files\Aitek\Tachlink\USB Device Driver\FTD2XX
 - Highlight file “FTD2XX” > click **OPEN**.
 - The following dialog box will once again appear:
[The file’FTD2XX.sys’ on FTDI FTD2XX Drivers Disk is needed]
 - Click **OK**.
 - Click **FINISH** to complete **Found New Hardware Wizard**.
 - Launch TACHLINK and select Program > COMM Port and either USB or applicable COMM port to establish communication per section 4.2.1.2 of manual. Make wiring connections per section 3.5 (USB) or section 3.6 (RS485). A dialog box may appear when TACHLINK is first launched: **Couldn’t open .cfg file**. Click **OK**, the file is generated when first opened.

4. Tachometer Functions

Both TACHPAK and TACHTROL are highly configurable instruments. This allows the instrument to perform very simple to very complex tasks. Both are designed to communicate with remote TACHTROL^{plus} displays via a dedicated LAN (Local Area Network). Each tachometer series can be connected to up to eight remote TACHTROL^{plus} displays (when using the TACHTROL series, the instrument counts as one display), a PC loaded with TACHLINK through USB2.0 and a PC loaded with TACHLINK through RS485 simultaneously. Only one tachometer can be connected to any given network and it serves as bus master for that network. The tachometer instrument also serves to store the active configuration constants that define its behavior. Both TACHPAK and TACHTROL cannot be connected on the same network. In terms of programming, any TACHTROL display panel or remote PC can be used to program the tachometer. Whenever a user begins to change configuration data in the tachometer, unlock is granted for only that port and all other ports are locked out until the programming cycle is completed. During programming, all other ports on the LAN will continue to monitor and display active process information. All configuration constant data is stored in the tachometer instrument and is global to the entire network. Each display, however, can be configured to display different information. For example, Remote Display 1 can be configured to display channel A and channel B information while Remote Display 2 may display channel B and the result of a calculation (Equation)

4.1. Programming The Tachometer

Programming either through the front panel or via TACHLINK has been designed to be as similar and intuitive as possible. Programming through the front panel utilizes a series of nested menus. The user navigates through the menus and changes data via a set of Up, Down, Left, Right arrows. TACHLINK is included with all TACHPAK AND TACHTROL products and simplifies the mechanics of programming. Anyone familiar with Windows can easily navigate through a series of tabbed screens. Each screen is designed to contain logically associated

functions and tracks the nested menus used in front panel programming. TACHLINK also allows additional function including Analog output calibration (see section 4.2.5.2) as well as the ability to track and plot rate information over a long period of time. (see section 4.2.9) Programming can be accomplished at either the installation site or off site, then debugged, with features integrated in the tachometer, all prior to committing to the first “live” run.

When programming a TACHPAK, it is necessary to have either a TACHTROL^{plus} or TACHLINK to act as the communication gateway. Because of the high level of similarity, both front panel and TACHLINK programming will be discussed together.



There are functional differences between TT/TP10 and TT/TP30. The “10” series does not include Analog Output, Digital 1 & 2 outputs and the utility RS485 serial port. As such the “10” series omits those functions from the GUI and display menus. This discussion of programming focuses on the “30” series. Simply disregard discussion of those options that do not apply.

4.1.1. Basic Programming Rules

4.1.1.1. Exponential Notation

This tachometer device is designed to automatically switch from standard notation to exponential notation if the number to be displayed grows too large or too small for the number of digits supported by the display. Many user-defined constants must be input as exponential notation, especially when programming through the display front panel . Exponential notation allows the instrument to support high-resolution measurements and calculations without the need for an extreme number of digits on the display. For those unfamiliar with Exponential notation, the format is a base number followed by an “e” (exponent) to a given power of 10. If the sign preceding the exponent is positive, move the decimal point to the right the same number of places as the value of the exponent, if negative, move the decimal point to the left. When

the sign of the exponent is negative, the larger the exponent value, the smaller the number. When the sign is positive, the larger the exponent value, the larger the number.

For example:

- 1) $1.5674e-3 = 1.5674 \times 10^{-3} = 1.5674 \times .001 = .0015674$
- 2) $1.5674e+3 = 1.5674 \times 10^3 = 1.5674 \times 1000 = 1567.4$

-and-

- 3) $-1.5674e-3 = -1.5674 \times 10^{-3} = -1.5674 \times .001 = -.0015674$
- 4) $-1.5674e+3 = -1.5674 \times 10^3 = -1.5674 \times 1000 = -1567.4$

4.1.1.2. Number Line

TACHPAK and TACHTROL are designed to respond to both positive and negative real numbers. A reversal in target direction (ex. clockwise to counterclockwise) is interpreted as a negative speed. This concept is discussed in section 4.2.2.1. In order to utilize the concept fully, it is necessary to understand the number line and how it relates the relative magnitude of one number to the next.



In the figure shown, numbers to the left of zero are negative; the further left you go, the more negative the number gets. To the right of zero, numbers are positive; the further right you go, the more positive the number gets. In terms of relative magnitude, -50 is greater than -100, but +50 is less than +100. Of course, +100 is greater than -100.

For example, if a relay set point is set at -100 (alarm trip) and the alarm mode is to energize when the speed increases above the setpoint (EA), a speed of -99 would trip the alarm.

4.1.2. Using the Tachtrol and Tachtrol plus front panel

Both front panels have the same configuration and operate identically. Each front panel is equipped with a LCD graphics display, Up/Down/Left/Right navigation keys, an enter key and two function keys.

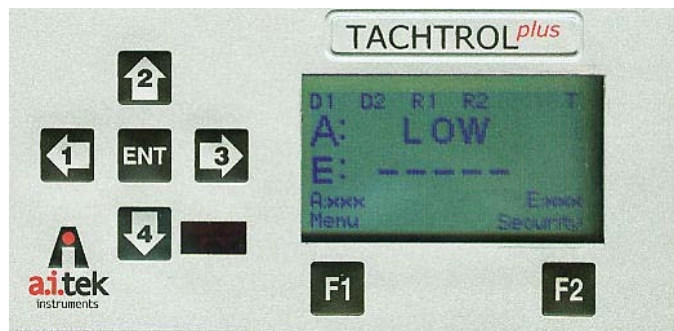











4.1.2.1. Function Keys allow access to different configuration modes and operational functions. The actual key function changes as the user makes selections and is indicated above the key on the LCD display. In the figure above, **F1** is used to access **MENU** and **F2** is to access **SECURITY**



4.1.2.1.1. **F1** (MENU) allows entry into the “Change” menu area where sub-menus are listed that allows configuration of user-defined constants in the Tachometer mode, Counter mode, Verify function and Diagnostics function. Once in those sub-menus, **F1** (Main or Prev) allows the user to navigate back to the main display screen.

4.1.2.1.2. **F2** allows entry into the security area. From Here the user can Reset an alarm, set Alarm Hold-Off, Lock/Un-lock the keypad, set the Display Address or Change Security Code. **F2** also allows the user to access the Next screen in a series of screens.

4.1.2.2. Up/Down/Left/Right Arrow Keys

  arrows are used to navigate to menu selections above and below your current position.   arrows are also used to increment and decrement a user-defined constant.   arrows are used to navigate over to a user-defined constant within the same line.  ,  ,  ,  keys also have the numbers 1 through 4 associated with them. They are used to configure and enter the security code.

4.1.2.3. Enter

The  key has several basic functions.  is used to select a highlighted menu item, toggle through a series of **Fixed Range Constants**, make a **Variable Range Constant** active for change, exit a **Variable Range Constant** character field or accept an input or choice.

4.1.2.4. Constant Types

There are two types of user-defined constants:

Fixed Range Constants: These constants limit the level of user-defined configuration from a pre-determined list and can be numerical or alphanumerical. Navigate to the line you wish to change with the Up/Down arrow keys. When the line is highlighted, depress the Enter key. The value will change for each time the key is depressed. When the change is complete, simply navigate off the current line with the up/down keys and to the next line to change.

Variable Range Constants: Constant values are numerical and can be changed within the resolution of the variable. Navigate to the line you wish to change with the up/down arrow keys. When the line is highlighted, depress the enter key. The cursor will be placed at the most significant digit of the variable. Use the up/down keys to change the value of that digit. Use the left/right keys to move to the next digit within the field to be

changed. When changes are complete, depress the enter key to return back to navigation.

After changes are made to any field, depress **PREV**, **F1** key, until you reach the first drop down menu then **MAIN** **F1** key. The tachometer will ask the question:

“Changes have been made to system parameters. Save the changes? Yes/No.”

Select yes to save the changes. The tachometer will display “Busy” during the downloading process. When **MAIN** re-appears, the instrument is ready to measure or accept additional changes. If at any time another display has been granted unlock and is in the process of changing data, all other displays are locked from making changes.



Regardless of where changes are made from; a remote display, TACHTROL, or the TACHLINK GUI, all global, system constants and changes are saved in the main tachometer instrument. *Changes have not been made unless you are asked if you wish to save them.*



If you need to get started with as little preparation as possible, please skip to section 5 for application examples and a list of starter databases.

4.2. Navigating Menus And Changing Constants

This section has two main purposes. The first is to define and illustrate tachometer functions. The second deals with the mechanics of navigating through menus and changing user-configurable constants. Section 5, Example Applications, will provide actual examples for the user to follow. Due to similarities in the mechanics of navigation through menus and changing constants, examples of each will not be shown, however they are all defined in detail. Instruction on navigating to, and changing constants is covered early in this section. Description of changing constants through the TACHTROL display or TACHLINK may vary with each subsequent example.

4.2.1. Main

The TACHTROL^{plus} main display screen serves as the visual information center. Along the top edge, the available Digital and Relay outputs are displayed as well as alarm status for each. Alarm status is shown as a highlighted box around the appropriate alarm designator. In the upper right corner, a T or C is displayed to indicate if the instrument is in the Tachometer or Counter mode. The tachometer can input two channels of frequency (A&B). In the center section of the screen the user can configure the instrument to display either one or both channels or a frequency channel and the mathematical result of an equation (E:). Just below the lower line, the user can define a set of units for the active channels being displayed above.

The display view shown indicates an alarm only on Digital Relay 1, Tachometer mode is active, Channel A and B are both active, user-defined Units for A is “rpm” and B is “frequency”. Menu is assigned to **F1**, Security is assigned to **F2**.

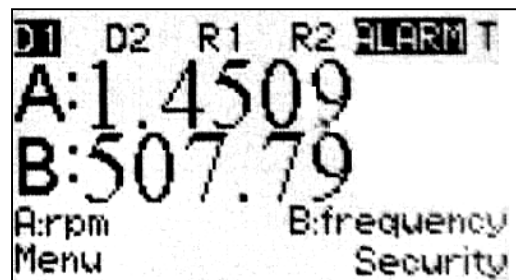

In contrast, TACHLINK is shown below. It displays Input A, B and Equation simultaneously. Input A is indicating 1.451 with units of “rpm”. Input B is indicating 507.743 with units of “Frequency”. The Equation line is indicating 1.4506209 (essentially “A”) and has no units. The display also indicates an alarm is in effect on DIG1 (in red). The green “Online” status light and Status bar at the bottom of the display indicate the tachometer is connected to the network and accessible through TACHLINK. Along the top edge of the GUI are a series of tabs that enable access to all of the user-configurable functions. They will be discussed in greater detail in subsequent sections of this manual.

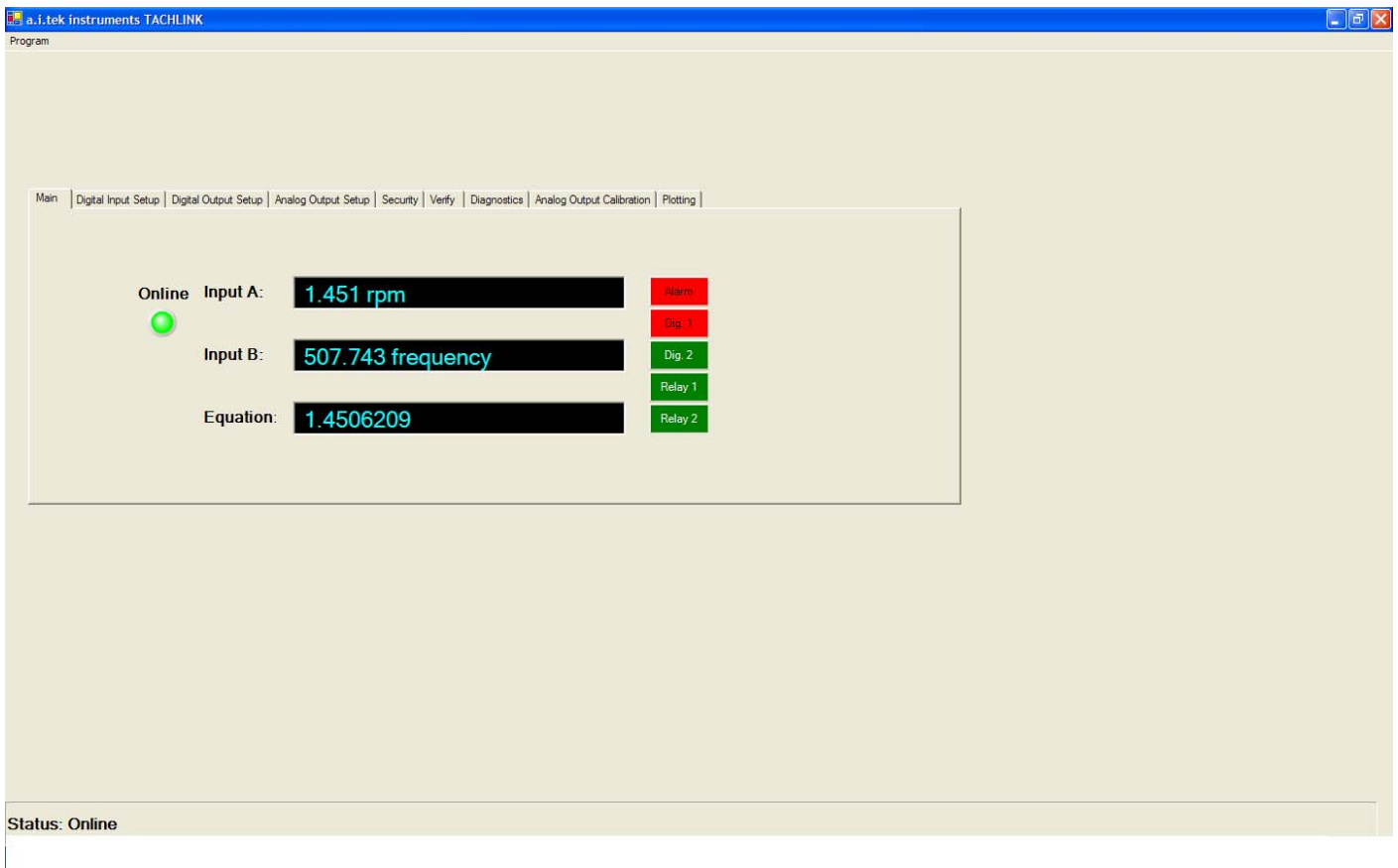

In the upper left corner is a pull down menu called **Program** containing **Database Open**, **Database Save**, **Comm. Port**, **About** and **Exit**.

4.2.1.1. Database Open and Database Save

As discussed earlier, user-defined configuration constants are stored in the tachometer instrument. If there is a need to propagate the same setup to other networks or to backup the data, **Database Save** allows the user to save the configuration as it exists on **TACHLINK** to a file on a PC. **Database Open** allows the user to retrieve the file and make it active. **Database Save** and **Database Open** are not active under the **Main** tab. Select any other tab to make them active. To retrieve a Database, click on **Database Open**, click on the desired file, then click **OPEN**. When a Database is retrieved, click on the **Main** tab to initiate the sequence to save the new constants as described in section 4.1.2.

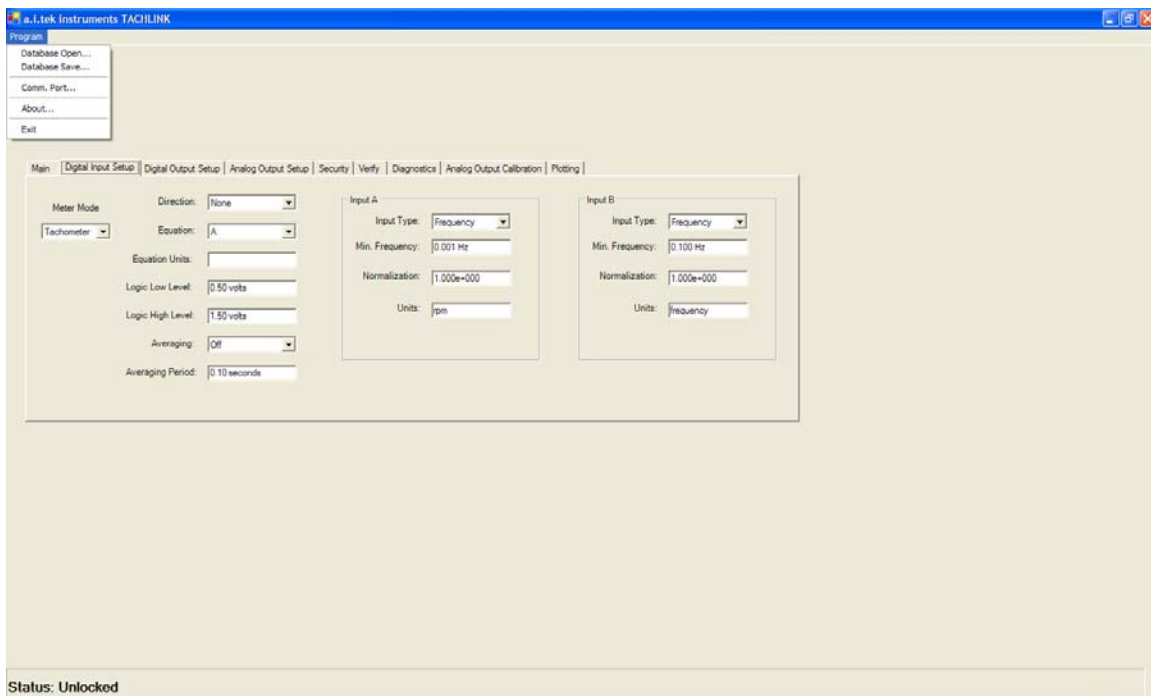

When a **Database** is saved, the **Security code** is saved with it. Make sure you take note of it.

4.2.1.2. Communication Port

TACHLINK can be connected to a tachometer network in a number of ways. Clicking on **Comm. Port** brings up the dialog box shown below. Available Com Ports will vary by computer, however the most common are USB, Com1, Com2, Com3, etc. The simplest and most convenient way to connect is through USB when the PC or laptop can be located near the Tachometer. If the user chooses, one of the Com ports can be assigned for serial communication for either RS485 (native to the tachometer) or RS232. This subject is discussed in more detail in sections 3.5 and 3.6. The active port is listed in the blue bar on the dialog box.

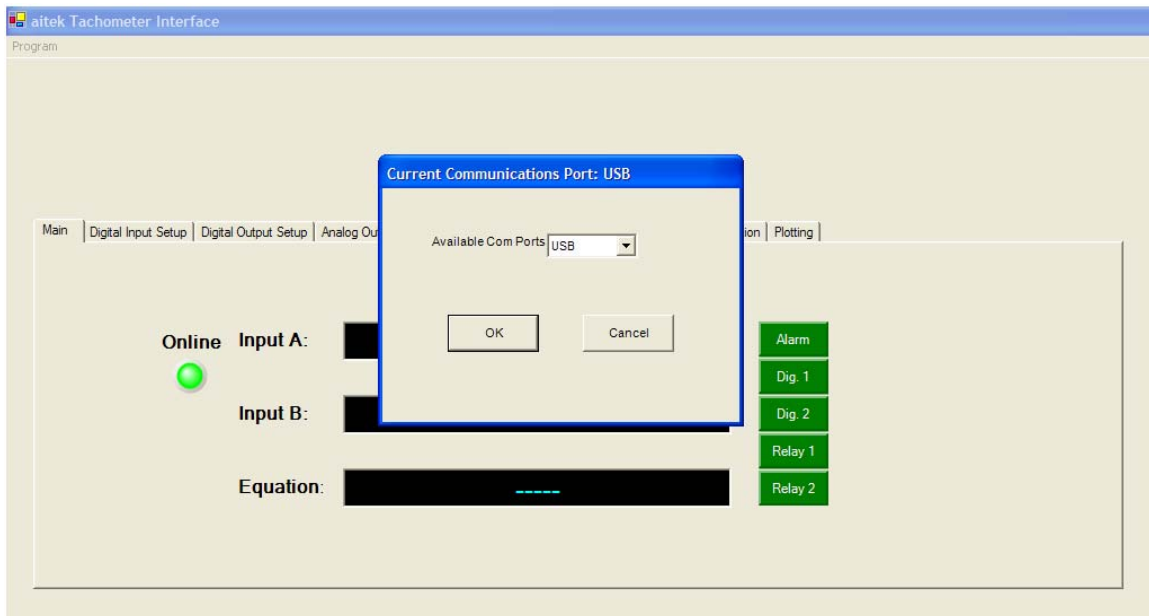

4.2.1.3. About

Provides information pertaining to TACHLINK, AI-TEK, and software revision.

Accessing change menus from the display is as described below.

From the Main screen, depress **Menu**, **F1**, to list the Change menus. Each menu allows access to different operating modes as well as user-configurable constants. Modes allow the instrument to have personalities that are tailored to specific function. The four main modes are Tachometer, Counter, Verify and Diagnostics.

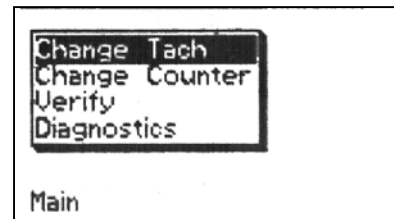
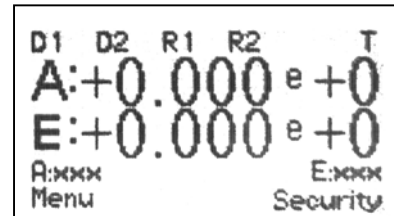

Below is an example of selecting **Tachometer** mode using TACHLINK. Simply click on the **Digital Input Setup** tab, then on the desired menu down arrow and then click on the desired selection. When all of the changes are complete, click on the **Main** tab and answer **Yes / No** to keep or discard the changes.

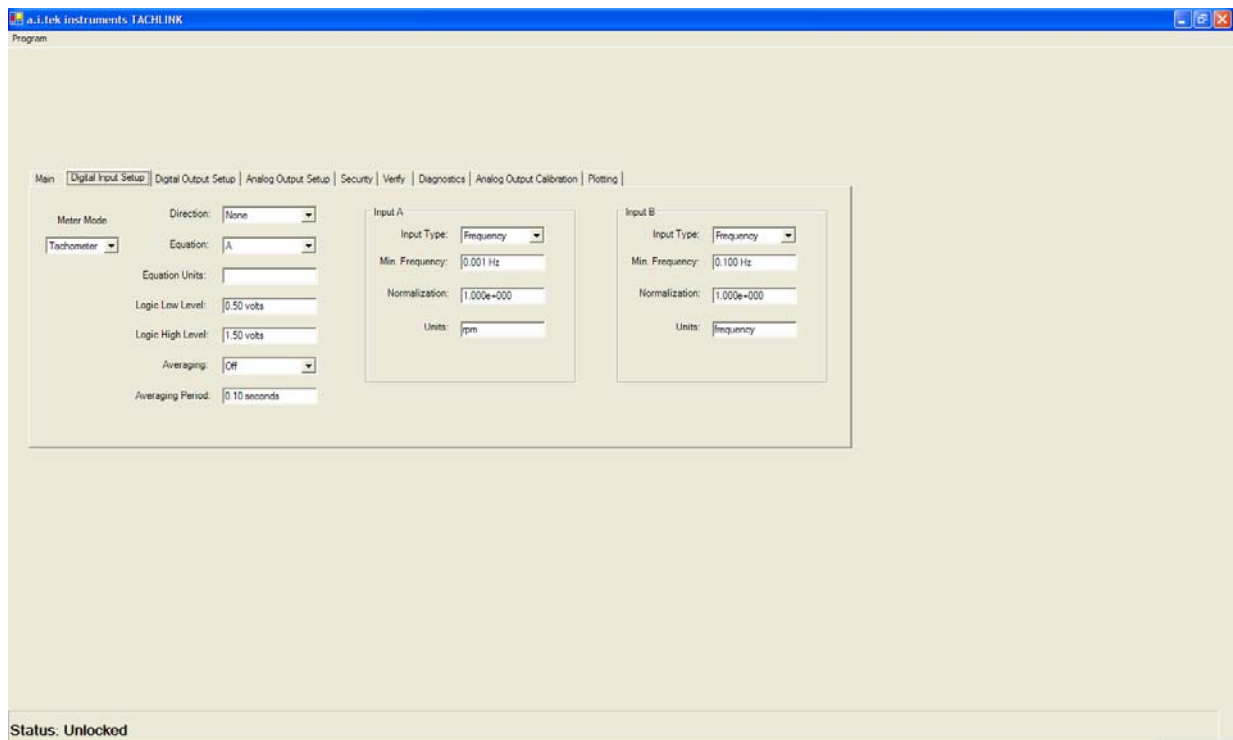

4.2.2. Input / Digital Input Setup (Tachometer Mode)

Input Setup allows the user to configure a set of global constants that affect how the tachometer reacts to incoming signals. In tachometer mode, the instrument measures and reacts to external events in terms of frequency or rate. All math and normalization operations as well as alarm setpoints, hysteresis and scaling are performed as frequency, speed or rate. When in Tachometer mode, both Period and Direction detection are active. In counter mode, only direction detection applies. Direction will be discussed in more detail in subsequent sections.



In order to access special menus for **Counter, Tachometer, Direction, etc**, the mode must first be selected and active. Select the mode (as illustrated below), exit to the Main screen and save the change. Re-entry into the menus will now provide the mode-specific constants. See



in section 4.2.3 for greater detail.

Depress **ENT** to select **Change Tach** and to display the Input/Output configuration menus. With **INPUT** highlighted, depress **ENT** to enter **INPUT SETUP**.

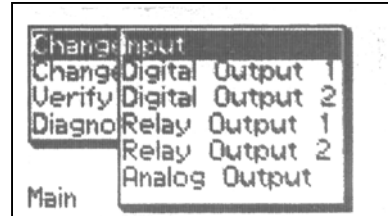

4.2.2.1. Direction Detection

Direction detection allows the tachometer to monitor and react not only to speed information, but to direction as well. In tachometer mode, a negative in front of the speed indicates a reversal in direction. Alarm setpoints and hysteresis can be set to react to target reversal. In counter mode, the count will increment in one direction and decrement in the reverse direction. Analog output can be configured to provide -20 to $+20$ mA. -20 mA indicates a reverse direction, 0 mA indicates stop and $+20$ mA indicates a forward direction. This will be discussed in greater detail in a subsequent section.

Direction detection is accomplished in two ways.

4.2.2.1.1. Quadrature

When set for direction mode, the instrument can decode direction based on two digital signals whose rising edges are spaced 45° to 135° apart such that one channel leads (or lags) the other. The signals can come from two, independent sensors, or from a bi-directional sensor such as an AI-TEK BH series sensor. The instrument can be user-configured to react to either A leads B (**ALB**) or B leads A (**BLA**) as a reversal in direction. See section 3.4 for connection information.

4.2.2.1.2. Direction Bit

When set for direction mode, the instrument can recognize an externally applied logic level present at the Direction input. An AI-TEK BH series bi-directional sensor can provide the logic level signal. The instrument can be user-configured to react to either high (**Bit High**) or low logic (**Bit Low**) level as a reversal in direction.

Once in **INPUT SETUP**, **Direction** is highlighted.

Depress **ENT** once for each choice of the Fixed Range Variable. Pictured here, **ENT** is depressed until Dir. Bit

High is displayed. Once the selection is made, the user can navigate to the next constant to change or view.

Depressing **4** will highlight, and make active, **Equation** and **Units**. If no more changes are to be made on this page the user may depress **Prev**, **F1**, to exit and save changes as described in section 4.1.2.

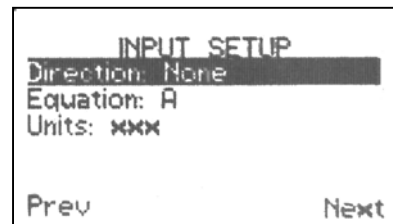



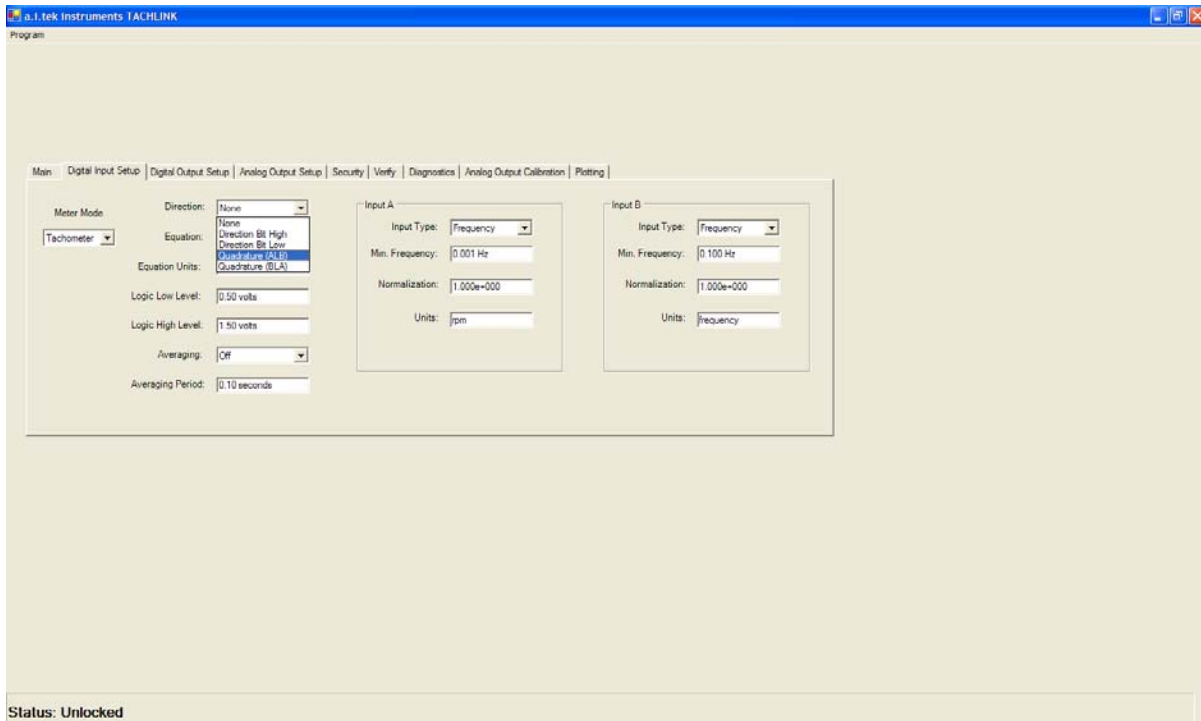

Below is an example of changing the Direction constant using TACHLINK. Simply click on the menu down arrow and click on the desired selection. When all of the changes are complete, click on the **Main** tab and answer **Yes / No** to keep or discard the changes.



4.2.2.2. Equation





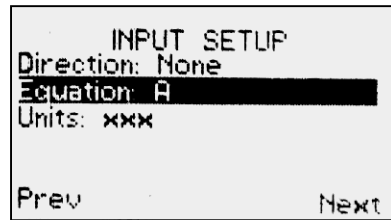





This global, Fixed Range Variable assigns a mathematical equation to both of the input frequencies. The equation allows calculation of the reciprocal for each channel as well as methods to mathematically relate the two channels. Available equations are A, 1/A, B, 1/B, A-B, B-A, (A+B)/2, A+B, AxB, A/B, B/A, (A-B)/A x 100, (B-A)/A x 100. Follow the previous examples for changing the **Direction** constant. Equation is one of the possible inputs that can be assigned to any of the outputs.

From the previous section, navigate to **Equation** using  until **Equation** is highlighted. Toggle through the available equations using . Navigate off using  or .



4.2.2.3. Units (For Equation)

The units apply only to the equation. Additional units can be specified for Input A and B, described later in a subsequent section. Up to 10 characters (numbers, letters and symbols) can be used to describe the units associated with this constant. The unit label is then displayed to allow the user to know, at a glance, what is being measured or calculated. Characters are selected from a pick list when programming from a TACHTROL display or simply typed in when using TACHLINK.

From the previous section, navigate to **Units** using  until **Units** is highlighted. Depress  to make active. Toggle through the available characters using  or . When the first character is selected, depress  to move to the adjacent character. Repeat use of  or  to make the next selection. Repeat this sequence up to 10 times. If at anytime the user wishes to remove the **Units** label, depress **Clear**. When complete depress  to exit from change. Navigate off using  or . If no more changes are to be made on this page the user may depress **Prev**, , to exit and save changes as described in section 4.1.2.

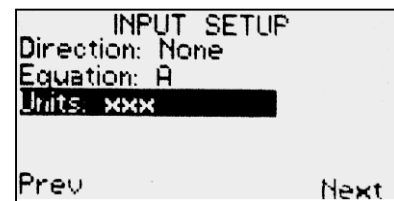

4.2.2.4. Logic Low / High

Both High and Low logic levels are Variable Range Constants and can be adjusted by the user to tailor the input to provide the largest noise margin possible or to filter against specific amplitude levels. Logic levels are adjustable as positive numbers only.

From the **INPUT SETUP** pages described in section 4.2.2.3, depress **Next**, **F2**, to navigate to the next page. In this example, the **Logic Low level** will be changed. This is a variable range constant and requires the user to change the number.

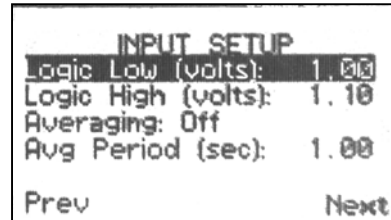

Depress **ENT** to make the constant active for change. The cursor highlights the most significant digit and is required to enter logic levels of 10 or more.

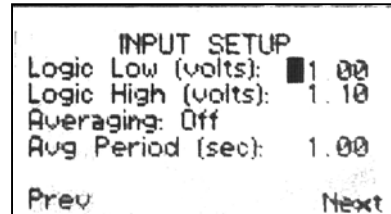

Depress **3** to navigate the cursor to the first digit to be changed for this example. Use **2** or **4** to increment or decrement the number as required. Use **3** for each additional digit to change. In this illustration no changes are being made. When changes are complete, depress **ENT**.

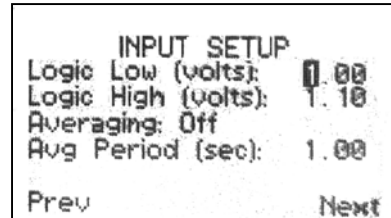

Logic High is changed in the same manner. In this case, it has been changed to 2.20. When changes are complete, depress **ENT**. If no more changes are to be made on this page the user may depress **Prev**, **F1**, multiple times to exit and save changes as described in section 4.1.2.

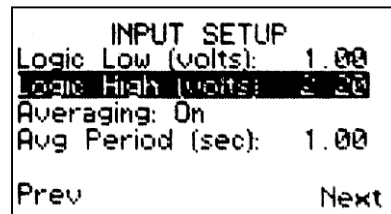
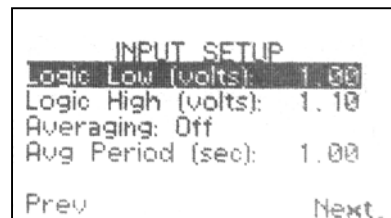

Below is an example of changing the **Logic High Level** constant using TACHLINK. Simply highlight the dialog box and type in the desired level. You do not need to type the unit “Volts”. When all of the changes are complete, click on the **Main** tab and answer **Yes / No** to keep or discard the changes.

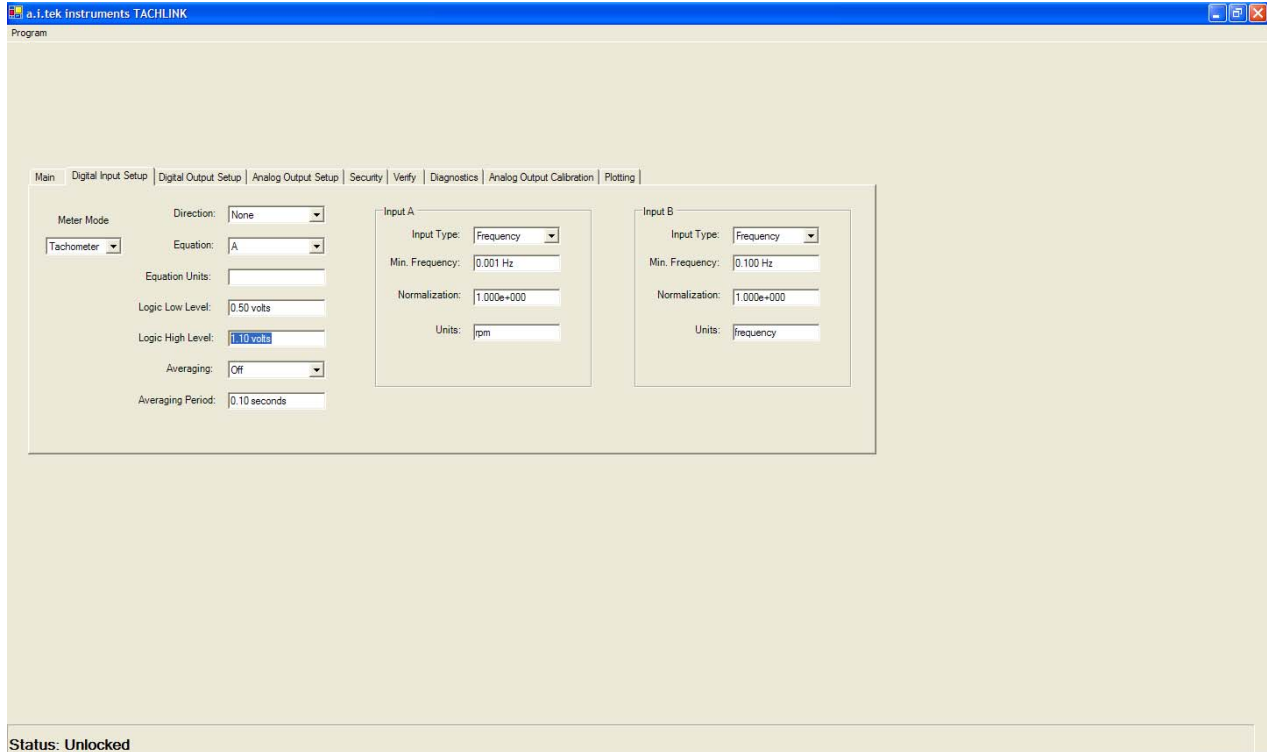

When logic levels are set very low, unused input channels will pick up ambient noise and potentially interpret noise as signal. Tie any unused inputs to ground through a 1K Ω resistor.



4.2.2.5. Averaging and Average Period

This Variable Range Constant can be turned **On** or **Off** and allows the instrument to average multiple input cycles. The effect is to help smooth out input frequencies that are “hunting” and not as stable as required. Adjustment is in seconds from .05 to 60.



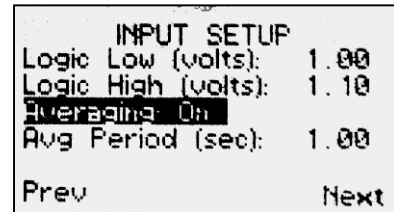

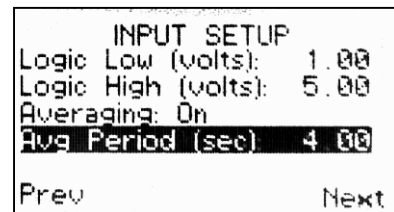

From section 4.2.2.4 navigate to **Averaging** using .

With **Averaging** highlighted, toggle between **On** or **Off** using .



Navigate to **Average Period** using . Depress  to make the constant active for change. The cursor highlights the most significant digit and is required to enter values of 10 or more.



Depress  to navigate the cursor to the first digit to be changed for this example. Use  or  to increment or decrement the number as required. Use  for each additional digit to change. In this illustration, the number was set to 4.00. When changes are complete, depress . If no more changes are to be made on this page the user may depress **Prev**, , multiple times to exit and save changes as described in section 4.1.2.



Averaging should only be applied where a “smoothed” speed can be tolerated and where the exact speed does not need to be known. When **Averaging** is applied, all outputs including Digital, Relays, Analog and Display are affected. Averaging will increase the amount of time the instrument uses to respond to an alarm condition and the response is based on the mathematical average.

4.2.2.6. Input Setup / Input A & B

Input Setup for input channels A & B are specific to each input, however the actual constants available and the mechanics for configuration are the same.

4.2.2.6.1. Normalization

Normalization is a mathematical Variable Range Constant used to convert the input frequency into a number that is useful to the user. For instance, the output of a sensor connected to a wheel driving a conveyor belt is in frequency, however, feet per minute may be more appropriate. For example:

Assuming a 0.5 ft diameter wheel and a frequency of 10 cycles/sec;

$$\text{Feet/minute} = (\text{cycles/sec}) \times (60 \text{ sec/minute}) \times (\pi D/\text{cycle})$$

$$= (10 \text{ cycles/sec}) \times (60 \text{ sec/minute}) \times (\pi \times 0.5/\text{cycle})$$

$$= (10 \text{ cycles/sec}) \times (94.3)$$

$$= 942.5 \text{ feet per minute}$$

Therefore the calculated rate is **942.5 ft/min** and the normalization factor (in this instance) to convert cycles /sec to feet/minute = **94.3**

Normalization is entered as a positive or negative number. When using a TACHTROL display enter the number as an exponent (see section 4.1.1.1). Simply type the desired number and polarity when using TACHLINK.



Normalization is mathematically applied to the input frequency first, then **Equation** is applied to the result.

From the **INPUT SETUP** pages last described in section 4.2.2.5

Depress **Next**, **F2**, to navigate to the **Input A Setup**

page. **Normalization** will be highlighted. Depress **ENT**

to make the constant active for change. The sign

preceding the base number is highlighted. Use **2** or

4 to change the sign. Depress **3** to navigate the

cursor to the first digit to be changed for this example. Use **2** or **4** to increment or

decrement the number as required. Use **3** for each additional digit to change. Change

the exponent sign in the same manner as described for the sign preceding the base

number.

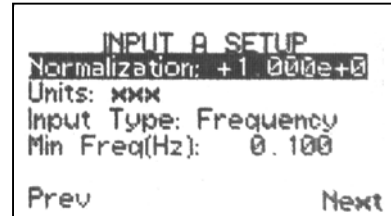

4.2.2.6.2. Units A & B

Up to 10 characters (numbers, letters and symbols) can be used to describe the units associated with this constant. The unit label is then displayed to allow the user to know, at a glance, what is being measured or calculated.

Characters are selected from a pick list when programming from a TACHTROL display or simply typed in when using TACHLINK

From the previous section, navigate to **Units** using **4**

until **Units** is highlighted. Depress **ENT** to make active.

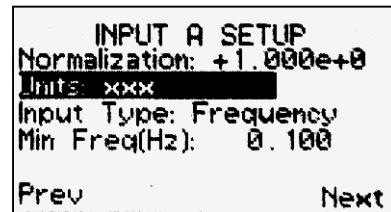

Make changes as described in section 4.2.2.3.



If **Direction mode** is active, only **Input A** will be active and there will not be a choice to configure **Input B**.

4.2.2.6.3. Input Type (A & B)

Input Type is a Fixed Range Constant and changes the instrument from Frequency to Period measurements. Period is a sub-mode to Tachometer mode and allows the instrument to measure and react to external events in terms of time. If the user is attempting to measure events that are spaced far apart, the frequency will be very low, however the period, or time between events will be relatively large. All math and normalization operations as well as alarm setpoints, hysteresis and scaling are performed as period. Period is the reciprocal of frequency.



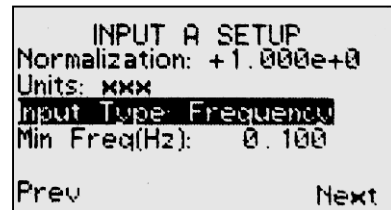



Navigate to the constant using  . Depress  to toggle between **Frequency** and **Period**.





When selecting **Input Type** using **TACHLINK**. Simply click on the menu down arrow and click on the desired selection. When all of the changes are complete, click on the **Main** tab and answer **Yes / No** to keep or discard the changes

4.2.2.6.4. Minimum Frequency / Maximum Period

As described earlier in this section, frequency and period have different uses. By defining what the **Minimum Frequency** or the **Maximum Period** is, the user instructs the tachometer how long to wait until zero speed is indicated. By carefully selecting these values, reaction time to long events that approach or reach zero can be significantly reduced. When **Frequency** is chosen from section 4.2.2.6.3, **Min Freq (Hz)** is active. When **Period** is chosen from section 4.2.2.6.3, **Max Period (sec)** is active. When the actual input rate falls past the specified **Min Freq / Max Period**, **“LOW”** is displayed.

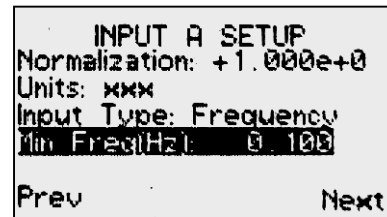
Navigate to the constant using  or . Depress  to make the constant active. Use  or  to increment/ decrement a digit and  or  to navigate to the next or previous digit. Follow the rules for changing a Variable Range Constant in section 4.2.2.4 and save changes as described in section 4.1.2.



Depress **Next**, , to navigate to the **Input B Setup** page. Constants for **Input B Setup** are the same as for **Input A**. When changes are complete, depress . If no more changes are to be made on this page

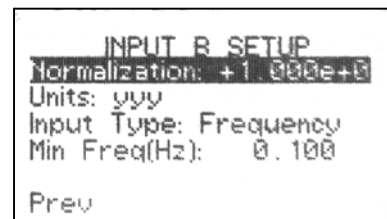

the user may depress **Prev**, , multiple times to exit and save changes as described in section 4.1.2.

4.2.3. Input / Digital Input Setup (Counter Mode)

In counter mode, the instrument counts external events on each channel and accumulates the total number for each channel independently. All math and normalization operations as well as alarm setpoints, hysteresis and scaling are performed as counts. In **Tachometer mode**, both **Period** and **Direction** detection are active. When in **Counter mode**, only **Direction** detection applies. When utilizing a direction signal the count will increment in one direction and decrement in the reverse direction.

Most of the User-configurable constants remain the same as in the **Tachometer Mode**. The differences are outlined below.



In order to access special menus for **Counter**, **Tachometer**, **Direction**, etc, the mode must first be selected and active. Select the mode (as illustrated below), continue to navigate to the first user-configurable constant and make an arbitrary change. This is necessary to force the tachometer to recognize that a change had been made. Exit to the Main screen and save the change. Re-entry into the menus will now provide the mode-specific constants.

From the Main screen, depress **Menu**, , to list the Change menus.

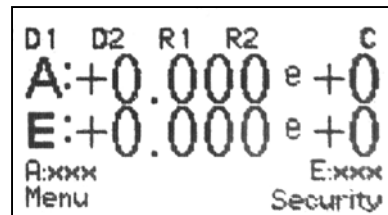

Depress  to navigate to **Change Counter**.

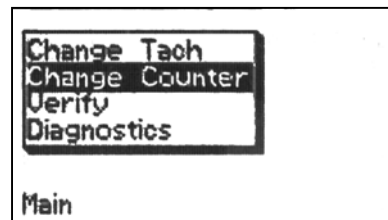

Below is an example of selecting **Counter** mode using TACHLINK. Simply click on the menu down arrow and click on the desired selection. When all of the changes are complete, click on the **Main** tab and answer **Yes / No** to keep or discard the changes.

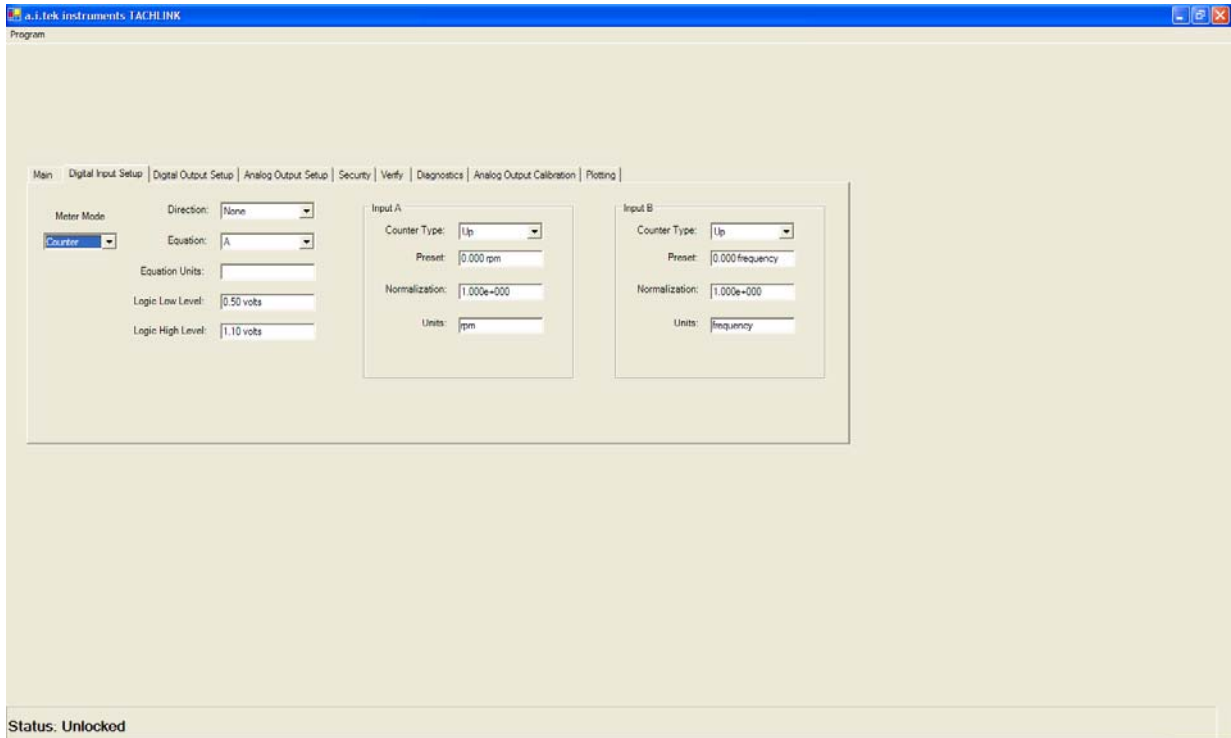

Depress **ENT** to select **Change Counter** and to display the Input/Output configuration menus. With **INPUT** highlighted, depress **ENT** to enter **INPUT SETUP**.

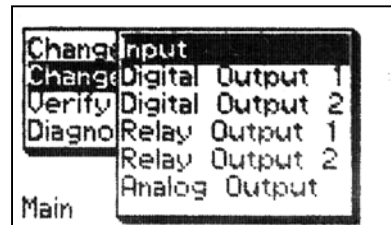

4.2.3.1. Direction, Equation, Units

The first page in **INPUT SETUP** containing **Direction**, **Equation** and **Units** is the same as in the **Tachometer** section. Follow applicable directions in section 4.2.2.

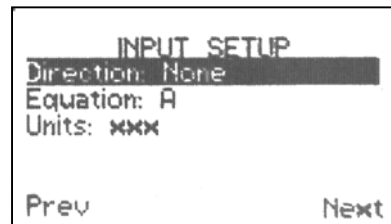

4.2.3.2. Logic Low, Logic High

Depress **Next**, **F2**, to navigate to the next page.

Averaging functions are not active in **Counter Mode**.

Making changes to **Logic Low** and **High** is the same as in the **Tachometer** section. Follow applicable directions in section 4.2.2.

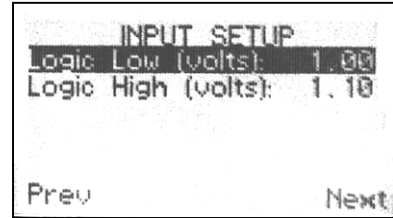

4.2.3.3. Normalization (Input A & B)

Depress **Next**, **F2**, to navigate to the next page. Making changes to **Normalization** for **Input A** and **B** is the same as in the **Tachometer** section. Follow applicable directions in section 4.2.2.

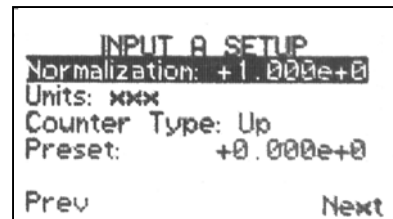

4.2.3.4. Units (Input A & B)

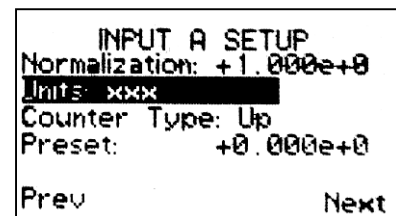

Depress **4** to navigate to **Units**. Making changes to **Units** is the same as in the **Tachometer** section. Follow applicable directions in section 4.2.2.



4.2.3.5. Counter Type

The instrument can be configured to count up from zero or some user-defined preset number or count down from a preset number. When used in conjunction with **Direction**, additional rules apply:





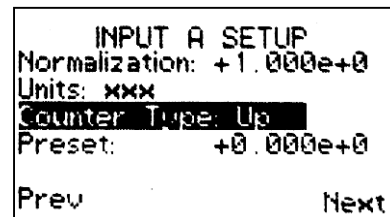



- Ex. 1: **If** Counter type = UP and Direction = ALB or Dir Bit High
THEN Count will increment in the positive direction until phase reverses (BLA) or direction bit goes low; count will then decrement
- Ex. 2: **If** Counter type = Down and Direction = BLA or Dir Bit Low
THEN Count will decrement in the negative direction until phase reverses (ALB) or direction bit goes high; count will then increment

Depress  to navigate to **Counter Type**. With **Counter Type** highlighted, depress  to toggle between **Up** and **Down**.





4.2.3.6. Preset

Preset sets a starting point for the count regardless of **Counter Type**. When counting up, either from zero or a **Preset**, the counts will increment to an alarm setpoint, trigger the alarm and continue up to the limit of the instrument. When counting down, either from zero or a **Preset**, the counts will continue to decrement to an alarm setpoint, trigger the alarm, switch from positive to negative and continue to the limit of the instrument is reached.

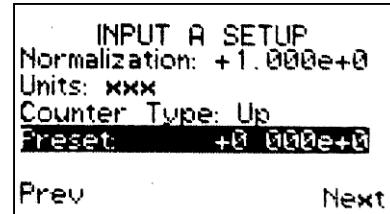
Depress  to navigate to **Preset**. With **Preset** highlighted depress  to make constant active for change. The sign preceding the base number is highlighted. Use  or  to change the sign. Depress  to navigate the cursor to the first digit to be changed for this example. Use  or  to increment or decrement the number as required. Use  for each additional digit to change. Change the exponent sign in the same manner as described for the sign preceding the base number.



Depress **Next**, , to navigate to the **Input B Setup** page. When changes are complete, depress . If no more changes are to be made on this page the user may depress **Prev**, , multiple times to exit and save changes as described in section 4.1.2.



If **Direction mode** is active, only **Input A** will be active and there will not be a choice to configure **Input B**.

4.2.4. Digital Output 1&2 (TP30 and TT30 Only), Relay Output 1&2 / Digital Output Setup (Tachometer and Counter Mode)

The tachometer has four switched outputs; Relay 1 and 2 are based on mechanical relays that provide high isolation and power switching but do not react as quickly as semi-conductors. Each mechanical relay has a set of normally open and normally closed contacts. Digital 1 & 2 are semi-conductor based outputs that reduce reaction time, but switch lower power levels and have only a true normally open condition. Just as with the mechanical relays, there is no polarity associated with these outputs. The switched outputs react when a particular setpoint is reached. A setpoint is a

value of normalized units that represents a significant point within the speed, frequency, period or count range of the input signal that causes a relay to change state. “Energized” describes the condition where the relay is “On” and the normally open contacts are closed. “De-energized describes the condition where the relay is “Off” and the normally open contacts are open. The frequency, after normalization may be expressed as cycles per second, gallons per hour, etc. Therefore, setpoint and hysteresis is expressed in the same user-defined, normalized units. There are several types of relay behavior divided into two major classifications; Failsafe and Non-failsafe. This is discussed in great detail in subsequent sections.



Output setup is the same for all **Digital** and **Relay** outputs in both Tachometer and Counter Mode. Therefore the following discussion applies in all cases. The terms speed, frequency, period or count are interchangeable for this discussion.

From the Main screen, depress **Menu**, **F1**, to list the Change menus.

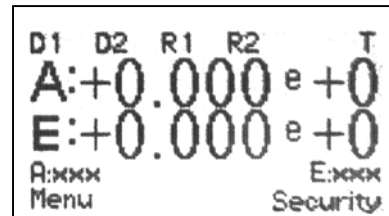

Depress **ENT** to select **Change Tach** and to display the Input/Output configuration menus. If the intent is to configure a **Counter** application, select **Change Counter**.

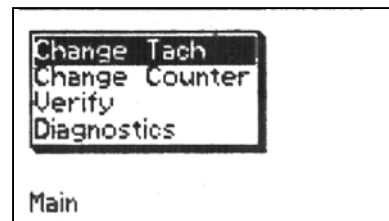

Depress **4** to navigate to **Digital Output 1**. Depress **4** additional times to configure other outputs.

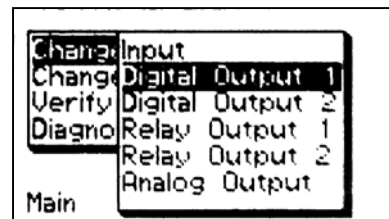

To enter **Digital Output Setup** in TACHLINK simply click on the corresponding tab.

Digital Output Setup allows the user to configure the outputs individually. Each output can be assigned to a specific normalized frequency input and to switch on (alarm) and reset in a particular manner. The following is a very detailed description of setpoints and switching behavior utilized by **Digital Output 1&2** and **Relay Output 1&2**.

4.2.4.1. Source

Source is a Fixed Range Constant. Each output can be assigned to any input. The user can decide to assign one or all of the outputs to a single input. The choices are **Input A**, **Input B**, **Equation** or **Off**. **Input A & B** are the normalized values from section 4.2.2.6. **Equation** uses the mathematical result from section 4.2.2.2 in addition to Normalization. The output can also be turned off by selecting **Off**.

From the **Digital Output SETUP** pages described in section 4.2.4 depress

ENT to make the **Digital Output 1 Setup** active.

Depress **ENT** to toggle through **Input A**, **B**, **Equation** and **Off**. When complete, navigate to the next constant using **4** or save changes as described in section 4.1.2.



```
DIGITAL OUTPUT 1 SETUP
Source: Input A
Latch Mode: Off
On Delay (sec): 0.00
Off Delay (sec): 0.00
Output Switching: EA
Prev
```

4.2.4.2. Hysteresis Definitions And Setpoint Classifications



The function of hysteresis is to provide a dead band that will prevent premature release or engagement of a relay in the alarm condition. Each setpoint (alarm) value is associated with a hysteresis value that identifies when an alarm condition is considered to be resolved (safe) and the relay alarm state can reset. Hysteresis bias refers to the position of the hysteresis band relative to the setpoint. Overspeed setpoints have the hysteresis band

located or biased below the setpoint to allow the setpoint to trip (alarm) at the prescribed value as speed increases and to permit release of the setpoint when the speed decreases to a safe level. Underspeed setpoints are the opposite of Overspeed setpoints.

4.2.4.2.1. Latch Function

Latch Function is a Fixed Range Constant and is either **ON** or **Off**.

Latching a relay output overrides the hysteresis function and keeps the switched output on until it is reset either through the security function or a wired external reset circuit (see sections 4.2.6.1 and 3.4.3). This function allows the highest level of security and ensures an alarm will be maintained until an authorized person resets it.

From the previous section depress  to navigate to **Latch Mode**. With **Latch Mode** highlighted, use  to toggle between **Off** and **On**.

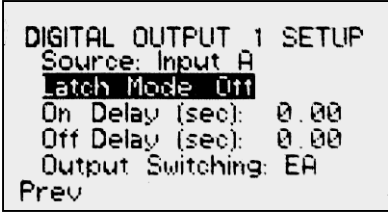

4.2.4.2.2. Delay Function (On & Off)

Delay is a Variable Range Constant. **ON** and **OFF Delay** functions keep the switched outputs from energizing or de-energizing for a given time period as specified by the user. This allows another layer of control in applications where erratic, short duration, changes may occur in a process and where it is known that they are not symptomatic of a problem. In these cases, a time-based delay will allow the tachometer to wait a user-specified period of time before turning an alarm on or off.

Navigate to **On Delay** using .



```
DIGITAL OUTPUT 1 SETUP
Source: Input A
Latch Mode: Off
On Delay (sec): 0.00
Off Delay (sec): 0.00
Output Switching: EA
Prev
```

Depress  to make the constant active for change. The cursor highlights the first active digit. In this case the most significant digit will not be changed.



```
DIGITAL OUTPUT 1 SETUP
Source: Input A
Latch Mode: Off
On Delay (sec): 0.00
Off Delay (sec): 0.00
Output Switching: EA
Prev
```

Depress  to navigate the cursor to the first digit to be changed.

```
DIGITAL OUTPUT 1 SETUP
Source: Input A
Latch Mode: Off
On Delay (sec): 2.00
Off Delay (sec): 0.00
Output Switching: EA
Prev
```

Use  or  to increment or decrement the number as required. Use  for each additional digit to change. In this illustration **On Delay** is being set to 2.00 seconds.

```
DIGITAL OUTPUT 1 SETUP
Source: Input A
Latch Mode: Off
On Delay (sec): 2.00
Off Delay (sec): 0.00
Output Switching: EA
Prev
```

When changes are complete, depress  to exit the change. If no more changes are to be made on this page the user may depress **Prev**, , multiple times to exit and save changes as described in section 4.1.2.

The mechanics of changing **Off Delay** are the same as for **On Delay**.



On or **Off Delay** should only be applied where a delayed response can be tolerated and where the exact speed does not need to be known. When **Delay** is applied, all outputs including Digital, Relays, Analog and Display are affected. **Delay** will affect the amount of time the instrument uses to respond to an alarm condition.



The Following sections 4.2.4.2.3 through 4.2.4.3.2 are not user-definable constants. The sections are included to help provide greater insight into the different types of switching characteristics. Failsafe, Non-Failsafe, Overspeed and Underspeed all relate to the **Setpoint Types** outlined in section 4.2.4.4.

4.2.4.2.3. Failsafe Setpoint

Failsafe refers to a mode of operation that utilizes the normally closed set of contacts on a relay, where during normal operation the relay is energized and the contacts are held open. In the event of power loss to the instrument, an alarm condition will result at the switched output device. Alarm condition refers to a switched output state that signals a fault to auxiliary or support equipment. This type of relay behavior should be used in applications where loss of speed control cannot be tolerated or will result in a hazardous condition. Only **Relay 1** and **Relay 2** have normally closed contacts and are therefore the only switched outputs capable of Failsafe switching.



4.2.4.2.4. Non-Failsafe Setpoint



Non-Failsafe refers to a mode of operation that utilizes the normally open set of contacts on a relay, where during normal operation the relay is energized and the contacts are held closed. In the event of power loss to the instrument, an alarm condition will not result at the switched output device. Alarm condition refers to a switched output state that signals a fault to auxiliary or support equipment. This type of relay behavior should be used in applications where loss of speed control can be tolerated and will not result in a hazardous condition. All **Relay** and **Digital** switched outputs are capable of non-failsafe switching.

4.2.4.3. Setpoint Categories

Both failsafe and non-failsafe setpoints have two categories of setpoint operation, Overspeed and Underspeed.

4.2.4.3.1. Overspeed Setpoint

Overspeed setpoints are used where control of a condition involving excess speed is required.

4.2.4.3.2. Underspeed Setpoint

Underspeed setpoints are used where control of a condition involving too low a speed is required

4.2.4.4. Output Switching / Setpoint Types

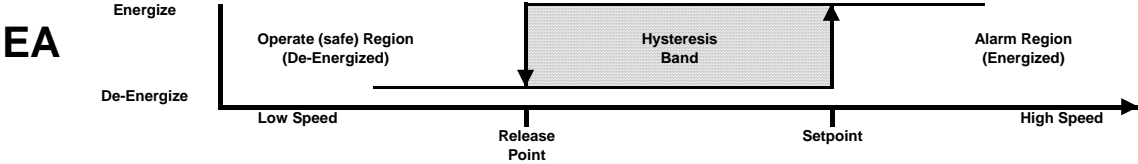

**ENERGIZE ABOVE;
OVERSPEED, NON-FAILSAFE**

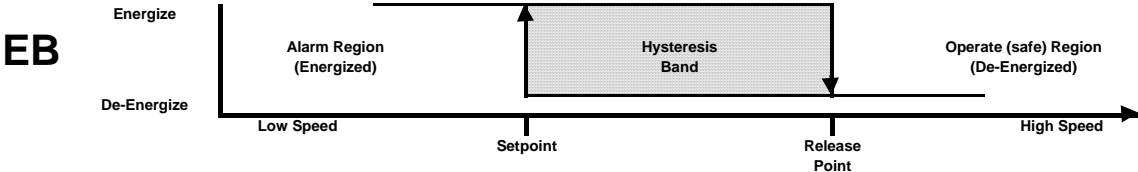

**ENERGIZE BELOW;
UNDERSPEED, NON-FAILSAFE**

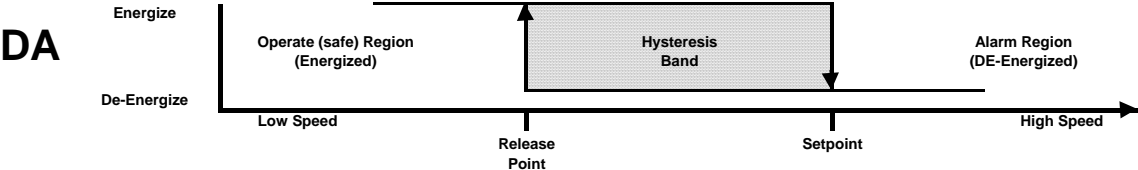

**DE-ENERGIZE ABOVE;
OVERSPEED, FAILSAFE**

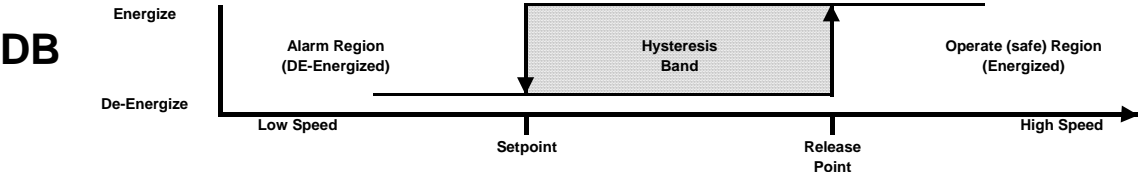

**DE-ENERGIZE BELOW;
UNDERSPEED, FAILSAFE**

4.2.4.4.1. EA (Energize above setpoint)

Used in applications where non-failsafe control of an Overspeed condition is desired. Operation is as follows:

- If the monitored application is operating at a speed below the setpoint, the relay is de-energized.
- If the speed increases beyond the setpoint value, the setpoint enters the alarm condition and energizes the relay.
- The relay will remain energized until the speed decreases to a value below the reset point of the hysteresis band at which point the relay is de-energized.

4.2.4.4.2. EB (Energize below setpoint)

Used in applications where non-failsafe control of an Underspeed condition is desired. Operation is as follows:

- If the monitored application is operating at a speed above the setpoint, the relay is de-energized.
- If the speed decreases below the setpoint value, the setpoint enters the alarm condition and energizes the relay.
- The relay will remain energized until the speed increases to a value above the reset point of the hysteresis band at which point the relay is de-energized.

4.2.4.4.3. DA (De-energize above setpoint)

Used in applications where failsafe control of an Overspeed condition is desired. Operation is as follows:

- If the monitored application is operating at a speed below the setpoint, the relay is energized.
- If the speed increases beyond the setpoint value, the setpoint enters the alarm condition and de-energizes the relay.
- The relay will remain de-energized until the speed decreases to a value below the reset point of the hysteresis band at which point the relay is energized.

4.2.4.4.4. DB (De-energize below setpoint)



Used in applications where failsafe control of an Underspeed condition is desired. Operation is as follows:

- If the monitored application is operating at a speed above the setpoint, the relay is energized.
- If the speed decreases below the setpoint value, the setpoint enters the alarm condition and de-energizes the relay.
- The relay will remain de-energized until the speed increases to a value above the reset point of the hysteresis band at which point the relay is energized.

EA, EB, DA, DB switching modes use both Fixed and Variable Range Constants

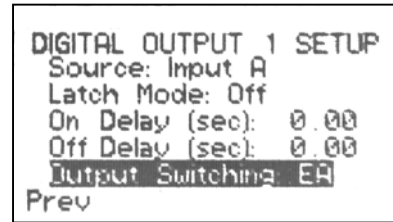
From the **Digital Output SETUP** pages described in section 4.2.4.2.2 use  to navigate to **Output Switching**. In this case **EA (Energize Above)** is the active Switching mode.





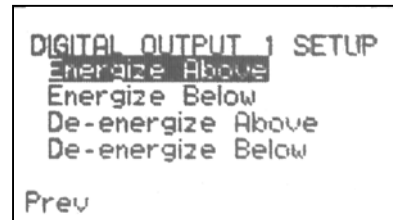





Depress  to move to the next page. All of the Output Switching modes are listed. Use  to navigate to the desired mode. In this case **EA** is selected for change.



Depress  to move to the next page

The highlighted constant is associated with **Safe** (alarm off) setpoint where the alarm will release once speed has decreased to this point or below. To change the constant depress

 while it is highlighted. The sign preceding the base number is highlighted. Use  or  to change the sign.

Depress  to navigate the cursor to the first digit to be changed for this example. Use  or  to increment or decrement the number as required. Use  for each additional digit to change. Change the exponent sign in the same manner as described for the sign preceding the base number. Depress  to exit changes to the constant.

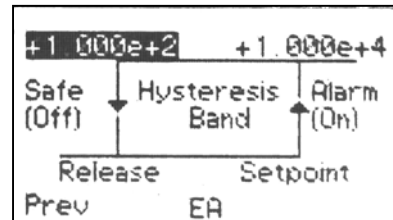

Use **3** to navigate to the **Alarm** (on) constant. To change the constant depress **ENT** while the constant is highlighted. Make changes as described with the **Safe** setpoint.

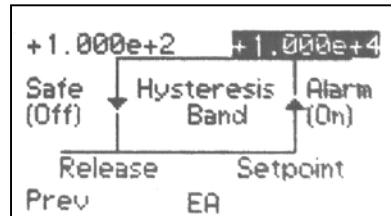

When changes are complete, depress **ENT** to exit the change. If no more changes are to be made on this page the user may depress **Prev**, **F1**, multiple times to exit and save changes as described in section 4.1.2.

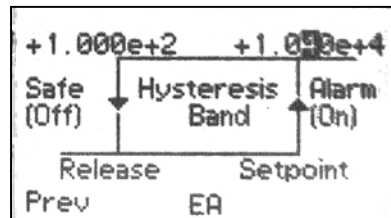
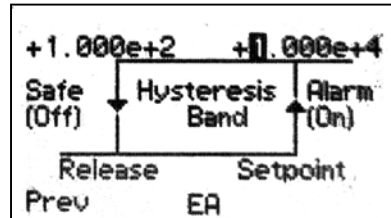

Below is a series of examples of selecting **Digital Output Setup** mode using TACHLINK. Simply click on the appropriate menu down arrows and click on the desired selection or type in the desired number. When all of the changes are complete, click on the **Main** tab and answer **Yes / No** to keep or discard the changes.

a.i.tek instruments TACHLINK
Program

Main | Digital Input Setup | Digital Output Setup | Analog Output Setup | Security | Verify | Diagnostics | Analog Output Calibration | Plotting

Output:

Source:

Latch Mode:

On Delay:

Off Delay:

Output Switching:

Status: Unlocked

a.i.tek instruments TACHLINK
Program

Main | Digital Input Setup | Digital Output Setup | Analog Output Setup | Security | Verify | Diagnostics | Analog Output Calibration | Plotting

Output:

Source:

Latch Mode:

On Delay:

Off Delay:

Output Switching:

Status: Unlocked

Digital Output Setup figures continued.

The screenshot shows the 'Digital Output Setup' window in the 'a.i.tek Instruments TACHLINK' software. The 'Output' is set to 'Digital Output 1' and the 'Source' is 'Input A'. The 'Latch Mode' is 'Off'. Both 'On Delay' and 'Off Delay' are set to '0.00 seconds'. The 'Output Switching' is set to 'De-energize Above'. The diagram shows a hysteresis band between a 'Release' point at $4.000e+002$ and a 'Setpoint' at $4.500e+002$. The state is 'Safe (On)' and 'Alarm (Off)'. The status at the bottom is 'Status: Unlocked'.

The screenshot shows the 'Digital Output Setup' window in the 'a.i.tek Instruments TACHLINK' software. The 'Output' is set to 'Digital Output 1' and the 'Source' is 'Input A'. The 'Latch Mode' is 'Off'. Both 'On Delay' and 'Off Delay' are set to '0.00 seconds'. The 'Output Switching' is set to 'De-energize Below'. The diagram shows a hysteresis band between a 'Setpoint' at $4.000e+002$ and a 'Release' point at $4.500e+002$. The state is 'Alarm (Off)' and 'Safe (On)'. The status at the bottom is 'Status: Unlocked'.

4.2.5. Analog Output (TP30 and TT30) Only

Analog output drives a current through devices such as recorders, meters, controllers and other instruments operated by a current loop. The output is precisely regulated to provide current that is proportional to the **Normalized** input speed or period when in **Tachometer** mode and count when in **Counter** mode. The proportional current is user-selectable in three ranges; 0 – 20mA, 4 – 20mA and –20 to +20mA.

4.2.5.1. Analog Output Setup

Setup allows the user to specify the Input **Source**, **Range** and **Max/Min** values for the speed range or count range. Setup is identical regardless of mode therefore instructions are the same as well.

From the Main screen, depress **Menu**, **F1** , to list the Change menus.

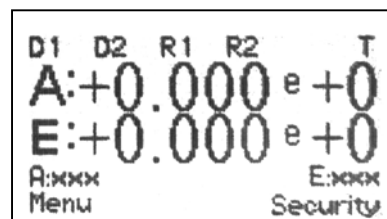

Depress **ENT** to select **Change Tach** and to display the Input/Output configuration menus. If the intent is to configure a **Counter** application, select **Change Counter**.

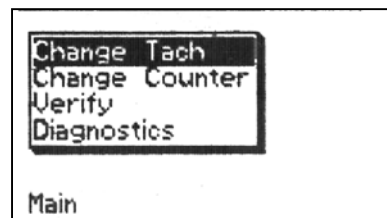

Depress **4** to navigate to **Analog Output** .

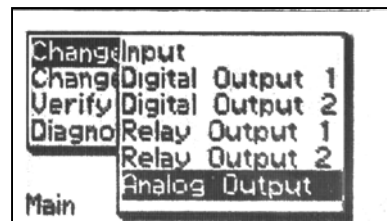

To enter **Analog Output Setup** in TACHLINK simply click on the corresponding tab.



4.2.5.1.1. Source

Source is a Fixed Range Constant. **Analog Output** can be assigned to any input. The choices are **Input A**, **Input B**, **Equation** or **Off**. **Input A & B** are the normalized values from section 4.2.2.6. **Equation** uses the mathematical result from section 4.2.2.2 in addition to Normalization. The output can also be turned off by selecting **Off**.

From the **Analog Output SETUP** pages described in section 4.2.5.1 depress

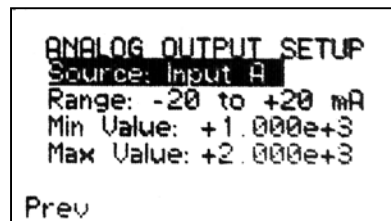

ENT to enter the **Analog Output Setup**. Depress **ENT** again to make **Source** active. Depress **ENT** to toggle through **Input A**, **B**, **Equation** and **Off**. In this example **Input A** is selected. When complete, navigate to the next constant using **4** or save changes as described in section 4.1.2..



4.2.5.1.2. Range

A Fixed Range Constant that refers to the three user-selectable ranges of proportional current; 0 to 20mA, 4 to 20mA and -20 to +20mA.

From the **Analog Output SETUP** pages previously described use  to navigate to

Range. Depress  to toggle through 0 to 20mA, 4 to 20mA and -20 to +20mA. When complete, navigate to the next constant using  or save changes as described in section 4.1.2.

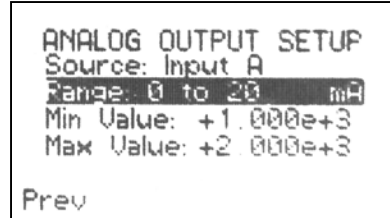

4.2.5.1.3. Min / Max Value

Min / Max Value are Variable Range Constants used to define the endpoints in the operating window of the output current. The **Min Value** defines the Input source value that will produce the minimum current. **Max Value** defines the Input source value that will produce the maximum current. For example, if the selected range is 0 to 20 mA , a **Min Value** of 1 kHz will produce 0 mA and a **Max Value** of 2 kHz will produce 20 mA. Since the output is proportional to the input and response is linear, it is easy to calculate expected values within the defined value limits. Therefore an input value of 1.5 kHz is at 50% scale and will yield 10mA. In the event direction detection is employed, values of -2 kHz to 2 kHz will yield -20 and +20 mA respectively and 0kHz will produce 0mA.

From the **Analog Output SETUP** pages previously

described, use  to navigate to **Min Value**. To

change the constant depress  while it is highlighted.

The sign preceding the base number is highlighted. Use

 or  to change the sign. Depress  to navigate the cursor to the first digit to be

changed for this example. Use  or  to increment or decrement the number as

required. Use  for each additional digit to change. Change the exponent sign in the

same manner as described for the sign preceding the base number. Depress  to exit

changes to the constant.

```
ANALOG OUTPUT SETUP
Source: Input A
Range: -20 to +20 mA
Min Value: +1.000e+2
Max Value: +2.010e+4
Prev
```

Use  to navigate to **Max Value**. Use the same

sequence to change this constant. When complete, save

changes as described in section 4.1.2.

```
ANALOG OUTPUT SETUP
Source: Input A
Range: -20 to +20 mA
Min Value: +1.000e+2
Max Value: +2.010e+4
Prev
```



Resolution is improved by keeping the span between **Min** and **Max Values** to a minimum. Always pick values to closely match the application.

4.2.5.2. Analog Output Calibration (TACHLINK ONLY)

Each tachometer instrument comes calibrated from the factory. In the event the user wishes to check calibration or tailor it to a specific loop resistance, calibration can be accomplished through TACHLINK.

Calibration can be accomplished either through the use of a resistance standard that represents the load or the actual load itself. The range of acceptable loop resistance is in the Specifications section. A calibrated, high resolution Voltmeter should be connected across the resistance or a high-resolution milli-ammeter connected in series with the load. When using a voltmeter, calculate the current with the formula $I = E/R$.

Click on the **Analog Output Calibration** tab. Click **Start** to initiate the calibration sequence.

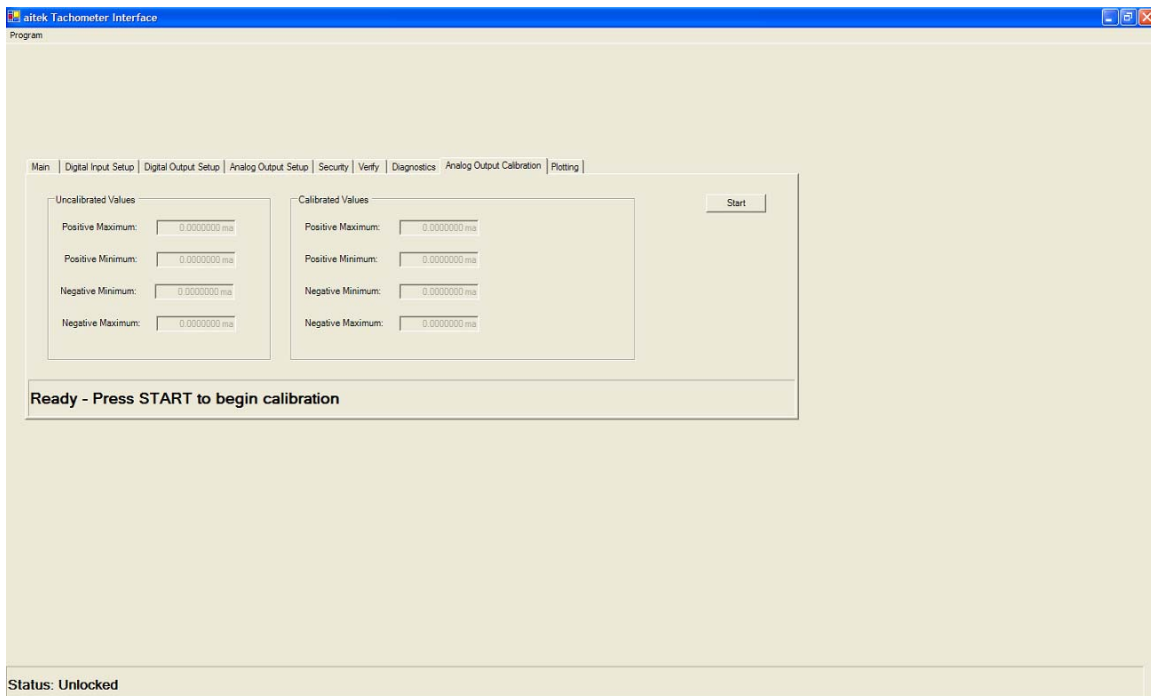

Each of the boxes in the **Uncalibrated Values** section will be highlighted in sequence, starting with **Positive Maximum**. When the box is highlighted, type in the measured value in mA and Tab to the next box. Once the uncalibrated values are taken, the **Calibrated Values** section will become active.

Repeat the measurement entry sequence. If successful, all boxes will indicate **Pass**. If **Fail** occurs, check all connections and values and repeat the calibration process.

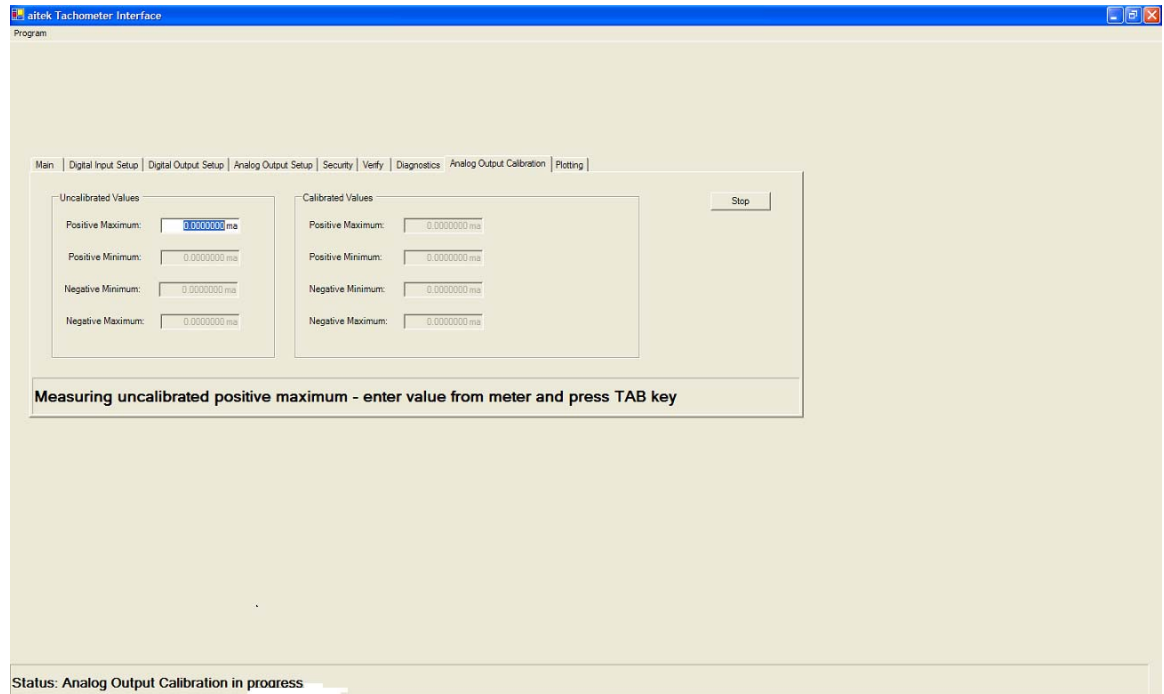

It is important to keep in mind rules related to loop compliance when running the tachometer on dc input voltage. For loop resistance values from 100Ω to 500Ω the dc input can be as low as 12 volts. For applications where 501Ω to 1000Ω are used the dc input voltage must be at least 20V.

4.2.6. Security

Security is comprised of a series of special functions that can be protected from unauthorized access by the user. These special functions are

Alarm / Counter Reset, Alarm Hold-Off, Keypad Lock, Display Address and Change Security Code. All are discussed below.

From the Main Screen depress **Security** **F2** to enter **Security** mode.

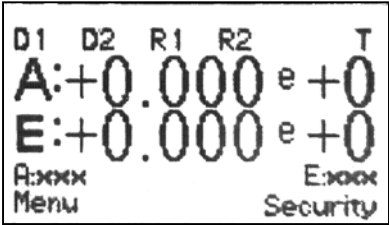

When using TACHLINK, simply click on the **Security** tab.

4.2.6.1. Alarm Reset

Alarm indications can be reset in a number of ways. Safe and Alarm setpoints in conjunction with hysteresis (already discussed in the Digital Output configuration section), an externally wired switch (see Section 3.4.3) and through the front panel or TACHLINK. There are some differences in Alarm Reset as discussed below.

An external switch hard-wired to the tachometer allows a simple and convenient method to reset alarms and counters (see section 3.4.3). This method does not provide security unless a keyed switch is used. An appropriate switch can be wired and placed in an appropriate location.

4.2.6.1.1. Tachometer Mode Alarm Reset

In Tachometer Mode, reset can only occur when the original alarm condition no longer exists, however, the Safe setpoint on the hysteresis band does not have to be reached. Reset then clears all of the qualified, outstanding alarm conditions and returns relay status to that prior to the alarm. If reset occurs while an alarm condition is still active, the alarm indication will momentarily reset, then re-alarm.

From Section 4.2.6, **Alarm Reset** is highlighted as soon as you enter the **Security** page. Depress **ENT** to reset alarms.

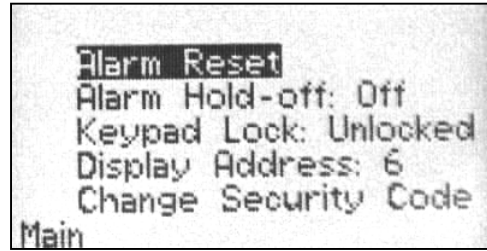

When using TACHLINK, simply click on **Alarm Reset**.



4.2.6.1.2. Counter Mode Alarm Reset

In **Counter Mode** the reset function serves two purposes. First, the count is reset to zero or to the **Preset** value (discussed in section 4.2.3.6), second, any alarms based on count are reset.

When accessing the display, follow the same directions as in section 4.2.6.1.1 for the **Tachometer Mode Alarm Reset**. The only difference is that two buttons (**Counter A Reset**, **Counter B Reset**) are available to reset the counters individually.

When using TACHLINK, simply click on **CTR A or B Reset**.





4.2.6.2. Alarm Hold-Off

Hold-Off provides an addition layer of control with respect to the handling of alarms. After an alarm has occurred, the user has the option to turn the alarm output off but maintain an **Alarm** indication on the display. In the case of the display, AHOLD appears on the top alarm status line.

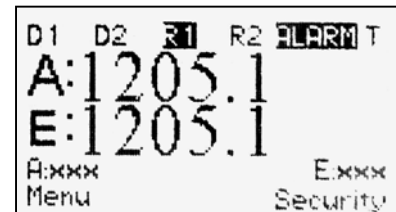
An alarm condition will be indicated as shown in the view of the Main screen.



Enter **Security** as discussed in the previous section and depress  to highlight **Alarm Hold-off**. Use  to cycle between **On** and **Off**. In this example, **Off** has been selected.

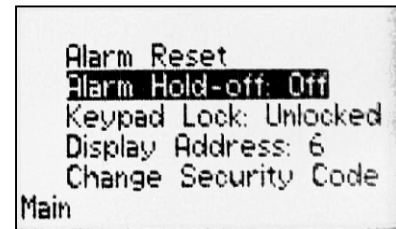

If **On** had been selected, the **Alarm Hold-off** indication would be as shown.

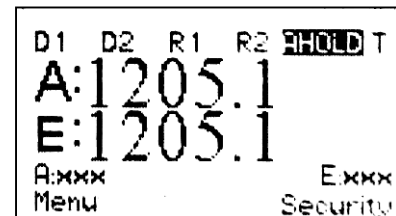

When using TACHLINK, click on the **Security** tab, click on the down arrow for the **Alarm Hold-Off** pull down menu, select **On** or **Off**. When changes are complete, click on the **Main** tab and answer **Yes / No** to keep or discard the changes. **ONLINE-ALARM HOLDOFF** appears on the bottom status line.



Alarm Hold-Off allows the user to turn off an alarm indication while an alarm is still occurring. The only indication that an alarm is active is the term AHOLD on the display and **ONLINE-ALARM HOLDOFF** on TACHLINK.



4.2.6.3. Keypad/Keyboard Lock

TACHTROL and TACHPAK have several levels of security.

Keypad/Keyboard Lock is the first layer of security.

4.2.6.3.1. Keypad Lock

Keypad Lock applies only when using a TACHTROL display, and allows a user full access to menus to view data, but not to make changes. The lock applies only to the display on which it is entered. All displays must be configured for lock separately. A security code is not required for **Keypad Lock** to work.

From section 4.2.6.2, use  to navigate to **Keypad Lock**. Use  to toggle between **Locked** and **Unlocked**. If changes are complete, depress **Main**  to return to the main screen.

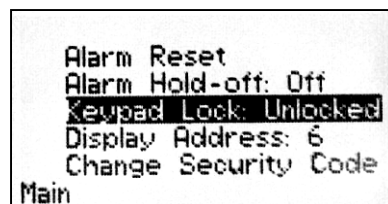



4.2.6.3.2. Keyboard Lock

Keyboard Lock applies only when using TACHLINK, and allows a user full access to menus to view data, but not to make changes. A security code is not required for **Keyboard Lock** to work. The lock applies only to TACHLINK. A security code is not required for **Keyboard Lock** to work.

When using TACHLINK, click on the **Security** tab, click on the down arrow for the **Keyboard Lock** pull down menu, select **Locked** or **Unlocked**. When changes are complete, click on the **Main** tab.





4.2.6.4. Display Address

Each TACHTROL^{plus}, TACHTROL 10 & 30 display on the network requires an address from 1 to 8. When shipped each display address is 0 so that when it is placed on the network it will not conflict with other displays. **Display Address** is entered locally at the display only. If two displays have the same address, the network will not function properly and odd behavior will result.

From the previous section use  to navigate to **Display Address**. Use  to toggle between addresses 1 through 8. If changes are complete, depress **Main**  to return to the main screen.



4.2.6.5. Security Code



An eight-digit, 65,536 combination, security code adds a second and more positive level of security. When a **Security Code** is entered, and the **Keypad Lock** function is on, all menus act as described in section 4.2.6.3 and no access is permitted to the security menu without first entering the code. In this condition, the user can view tachometer parameters, but cannot change any of them. Once the security code is entered, access is granted to the user but the Keypad Lock must still be reversed before the user parameters can be changed. The numbers for the eight-digit security code correspond to the , ,  and  arrow keys. The security code is global to the entire network.









In the event the user forgets the password they have chosen, a factory security number is available. 11223344 will always allow access to the instrument. The factory code is not active until a user-defined code is active.

4.2.6.5.1. Creating / Changing a Security Code



When a tachometer is shipped, no security code is active.

On the **Security** page use  to navigate to **Change Security Code**. Depress  to initiate entry of a new code. Ensure **Keypad Lock** is **Unlocked**.

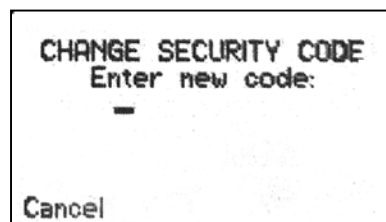

Enter an eight-digit code using the , ,  and  arrow keys. When the code is entered depress . If no code is desired, or to remove an old code depress  once in place of digits.



Re-enter the same code and depress . If no code is desired, or to remove an old code depress  once in place of digits. The user can now make additional changes to the **Security** page or depress **Main**  to return to the main screen.

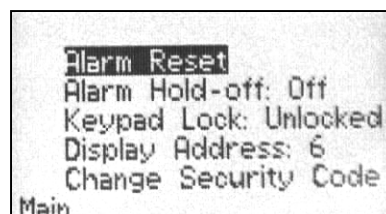
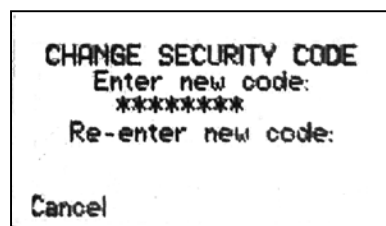







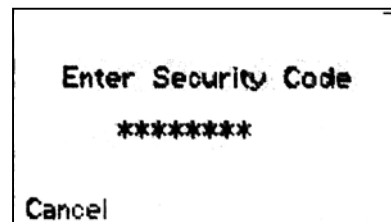
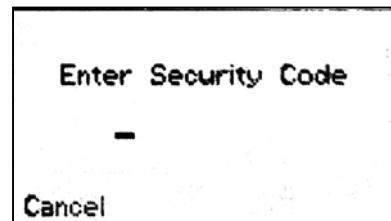
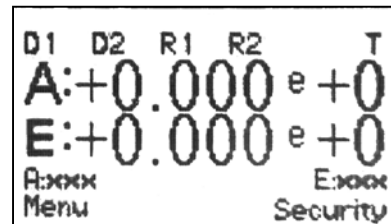

When using TACHLINK, click on the **Security** tab, type in an eight-digit security code in the **New Security Code** field using digits 1 through 4, and tab off the field. When changes are complete, click on the **Main** tab and answer **Yes / No** to keep or discard the changes. If no security code is desired, press **Enter** in place of the digits and complete the remaining instructions.

4.2.6.5.2. Entering a Security Code

Once a **Security Code** is active, entry to the **Security** page is restricted. Depress **Security** . The tachometer now asks for a security code.



Use the , ,  and  arrow keys. When the code is entered depress . If access to configuration menus is desired, use  to navigate to **Keypad Unlock** and depress  until **Unlocked** is active. Depress **Main**  to return to the main screen.

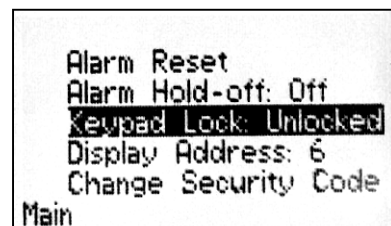

When using TACHLINK, click on the **Security** tab, and when asked, type in an eight-digit security code in the **Security Code** field using digits 1 through 4. Click **OK**. When changes are complete, click on the **Main** tab and answer **Yes / No** to keep or discard the changes. If no security code is desired, highlight the code, delete it, exit out to the Main tab and answer **Yes** to save.

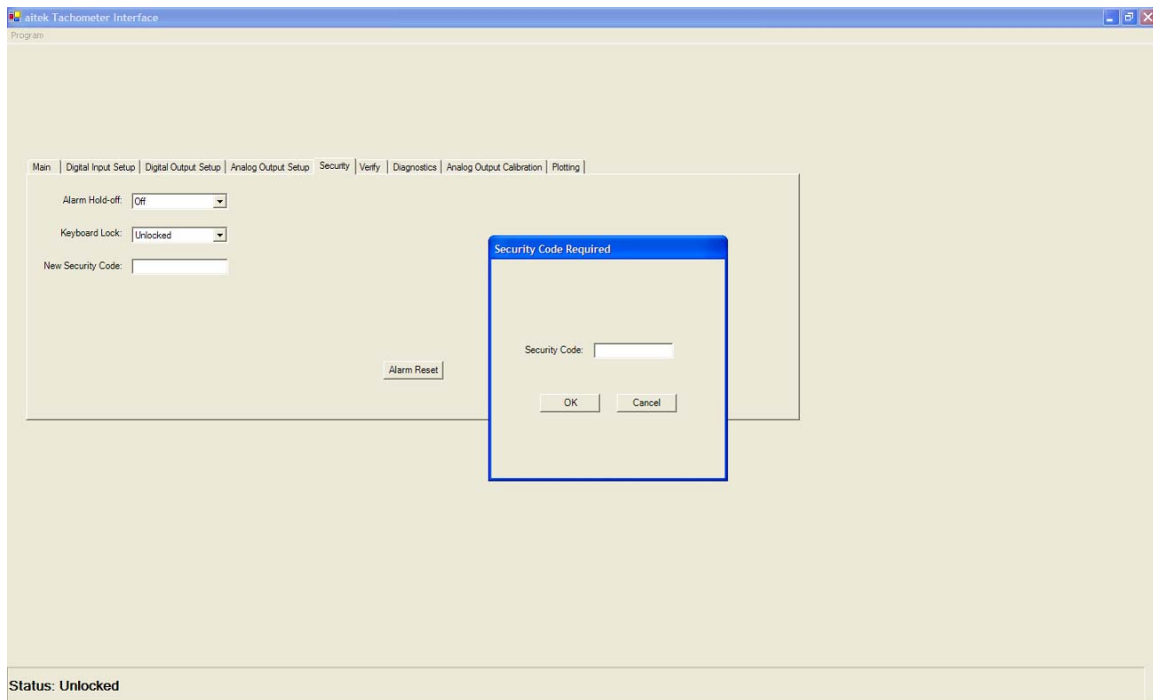

4.2.7. Verify

TACHTROL and TACHPAK tachometers are designed to allow verification of a user-defined configuration prior to committing the instrument and process to a “live” test. **Verify** allows the user to configure setpoints and outputs, then apply a simulation of the expected speeds or counts to the instrument to see how each will react. Each channel has an independent **Verify** constant. The user –defined values and units used in **Verify** should be the same as those applied to the outputs by the tachometer in normal operation.

For example, a sensor from an application is producing a 1000 Hz signal. The **Normalization constant** is 1.111 e0 and converts the frequency to gallons per hour and no math equation is applied. Therefore, the number that appears on the display, and used for all outputs is 1111 Hz and is the number to be applied in **Verify** mode.



When **Verify** is active (On) on any display, all other displays are locked until **Verify** is released (Off). **Verify** overrides current operation of the instrument.

An external switch hard-wired to the tachometer allows a simple and convenient method to initiate **Verify** (see section 3.4.3). This method does not provide security unless a keyed switch is used. An appropriate switch can be wired and placed in an appropriate location

From the main screen depress **Menu** **F1** to display the Input/Output configuration menus. Use **4** to navigate to **Verify**.

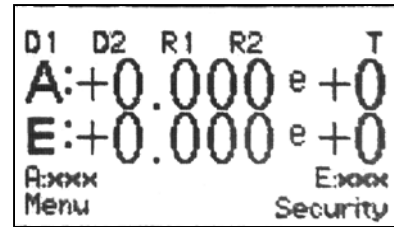

When **Verify** is highlighted, depress **ENT**.

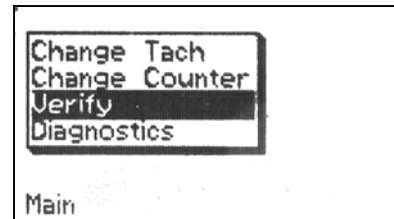

Once on the **Verify Mode** page **Input A** is already highlighted. Depress **ENT** to make the constant active for change. To change the constant depress **ENT** while it is highlighted. The sign preceding the base number is highlighted. Use **2** or **4** to change the sign. Depress **3** to navigate the cursor to the first digit to be changed for this example. Use **2** or **4** to increment or decrement the number as required. Use **3** for each additional digit to change. Change the exponent sign in the same manner as described for the sign preceding the base number. Depress **ENT** to exit changes to the constant. Use **4** to navigate to **Input B**. It is changed in the same manner as **Input A**.

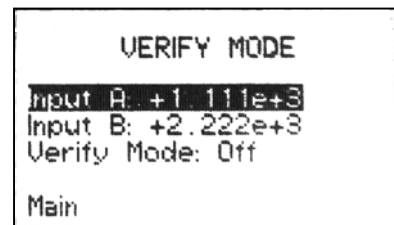

Depress **4** to navigate to **Verify Mode**. Use **ENT** to toggle between **On** and **Off**. When changes are complete, and no more changes are to be made on this page the user may depress **Main**, **F1**, multiple times to exit and save changes as described in section 4.1.2. Changes do not have to be saved in order for **Verify** to work. Save only if the constants will be used again. Constants can be changed while **Verify** is on to test multiple values.

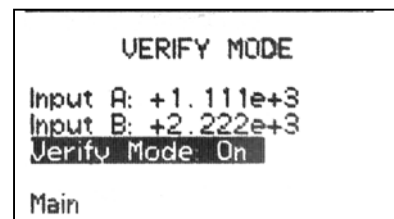

The main screen is shown here. The **VERIFY** indicator is on and highlighted. **A** is 1111.0. In this case the display has also been configured to display the result of any equation applied. Since display line **E** has been configured to show **A**, the **Verify** value is also displayed.

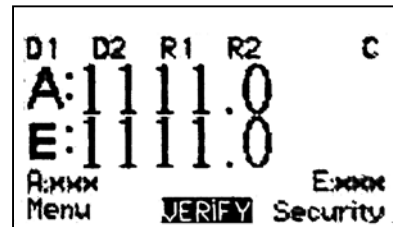

Turn **Verify** off in the same manner it was turned on.

When using TACHLINK, click on the **Verify** tab. Type in the **Input A** and **Input B Values**. Click the rotary switch to turn On/Off. When changes are complete, click on the **Main** tab and answer **Yes / No** to keep or discard the changes. Changes do not have to be saved in order for **Verify** to work. Save only if the constants will be used again. Constants can be changed while **Verify** is on to test multiple values.

When **Verify** is on, **VERIFY MODE** appears on the bottom status line.

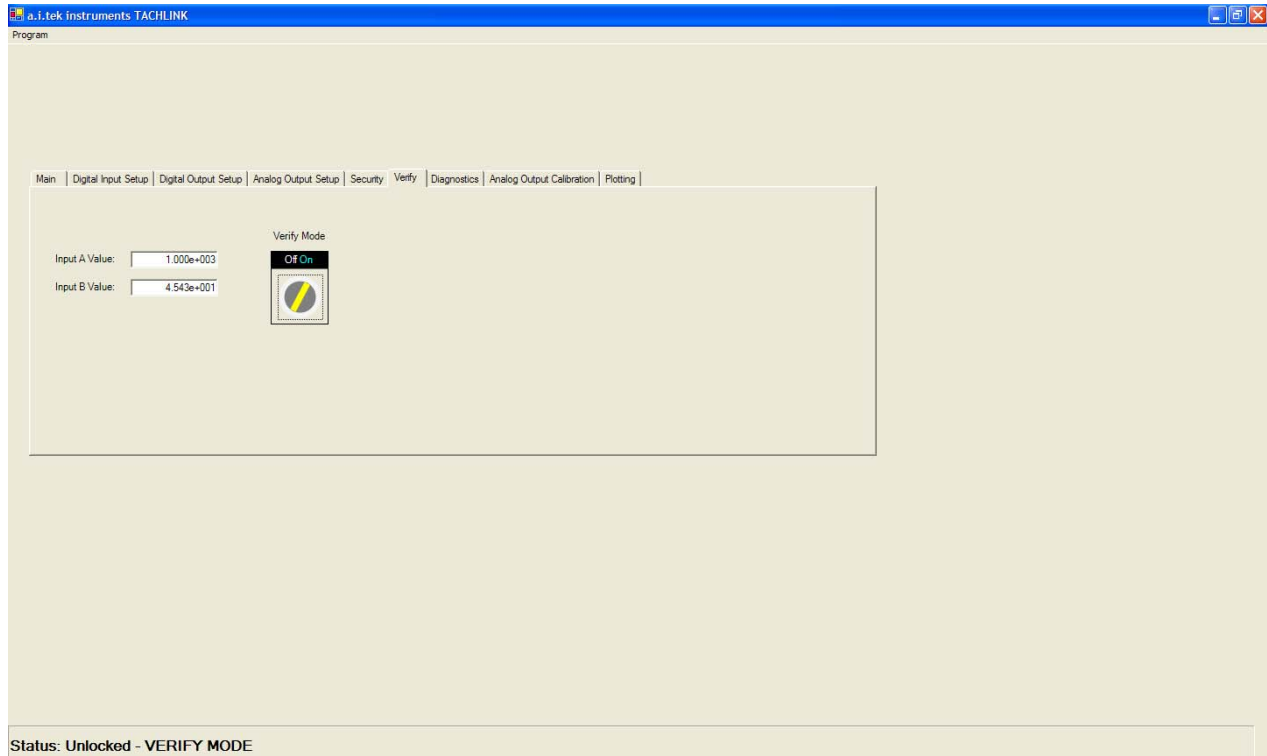



4.2.8. Diagnostics



TACHTROL and TACHPAK tachometers are designed to allow verification of operation of the 2 Digital outputs and 2 Relay outputs prior to committing the instrument and process to a “live” test. The outputs can be switched On/Off manually to see if they are working.



When **Diagnostics mode** is active (On) on any display, all other displays are locked until **Diagnostics mode** is released (Off). **Diagnostics mode** overrides current operation of the instrument.

From the Input/Output configuration menus in section 4.2.7 use  to navigate to **Diagnostics**. When **Diagnostics** is highlighted, depress .



Use  to navigate to the desired output to test. When highlighted depress  to toggle the output **On/Off**. Navigate to **Diagnostics mode**. When highlighted depress  to toggle **On/Off**. Changes do not need to be saved in order for **Diagnostics** to work. Outputs can be toggled on and off “live” while **Diagnostics** is active.

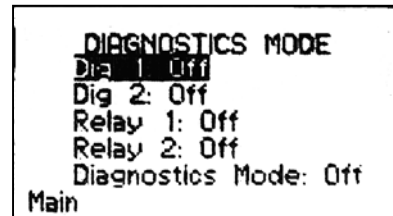

The main screen is shown here. The **DIAG MODE** indicator is on and highlighted. In this case D2 and R2 have been turned on.

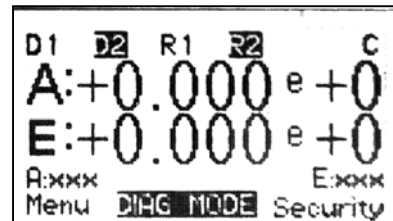

Turn **Diagnostics** off in the same manner it was turned on.

When using TACHLINK, click on the **Diagnostics** tab. Click on the button associated with the output you wish to turn on. Click on the rotary button to make **Diagnostics active**. Changes do not need to be saved in order for **Diagnostics** to work. Outputs can be toggled on and off “live” while **Diagnostics** is active.

When **Diagnostics** is on, **DIAGNOSTICS MODE** appears on the bottom status line.



4.2.9. Plotting (TACHLINK Only)

TACHLINK provides a tool that enables the user to monitor and track the process over an extended period of time. The plotting tool is compatible with all TACHTROL and TACHPAK tachometers. The data is recorded in one-second intervals and can be presented in both graphical or spreadsheet format and can be saved for future analysis.



Plotting uses approximately 8 to 12 MB of memory per day depending on how many plots are being created and will run indefinitely as long as disk space permits.

4.2.9.1. Plotting Setup

Plotting can track up to 3 sources of information. The **Normalized** result of **Input A** and **Input B** as well as **Equation** can be used to form a graphical plot and be saved as a spreadsheet. Each source has a user-configurable low and high threshold. These thresholds can be the same as applied to one of the outputs or other significant values.

Each input source also has a **Span** number associated with it. This is an output from the **Plotting** tool and is not user-configurable. **Span** keeps a running number when **Plotting** is active of the difference between the maximum and minimum values for each input source. The result is SPC-type information about the process being monitored. **Span** can be reset by exiting TACHLINK; then re-entering.

In TACHLINK, click on the **Plotting** tab. Configure the applicable **Thresholds** by highlighting the data box and typing in the desired values. Repeat this for one or all of the Input sources. Click on **Log To File** if you wish to save the plot data as a spreadsheet. Use the default save-to location or **Browse** to a file location of your choice.

Click on **Plot Input A**, **Plot Input B** or **Plot Equation**. This will make the plotting tool active and begin the plot. Separate windows will open for each plot.

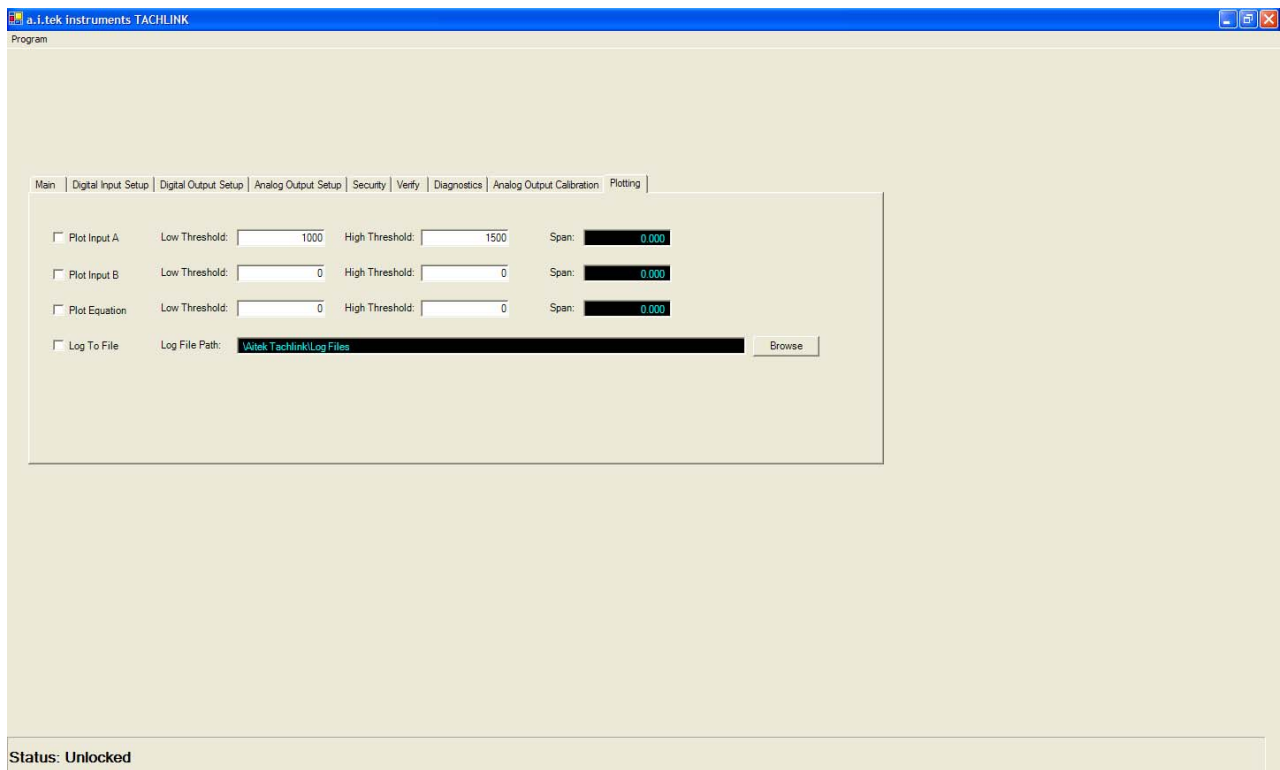

4.2.9.2. Plotting Output

The figure below shows that **Input A** is being plotted as the green trace. 900 is the **Low Threshold** (blue) and 1100 is the **High Threshold** (yellow).

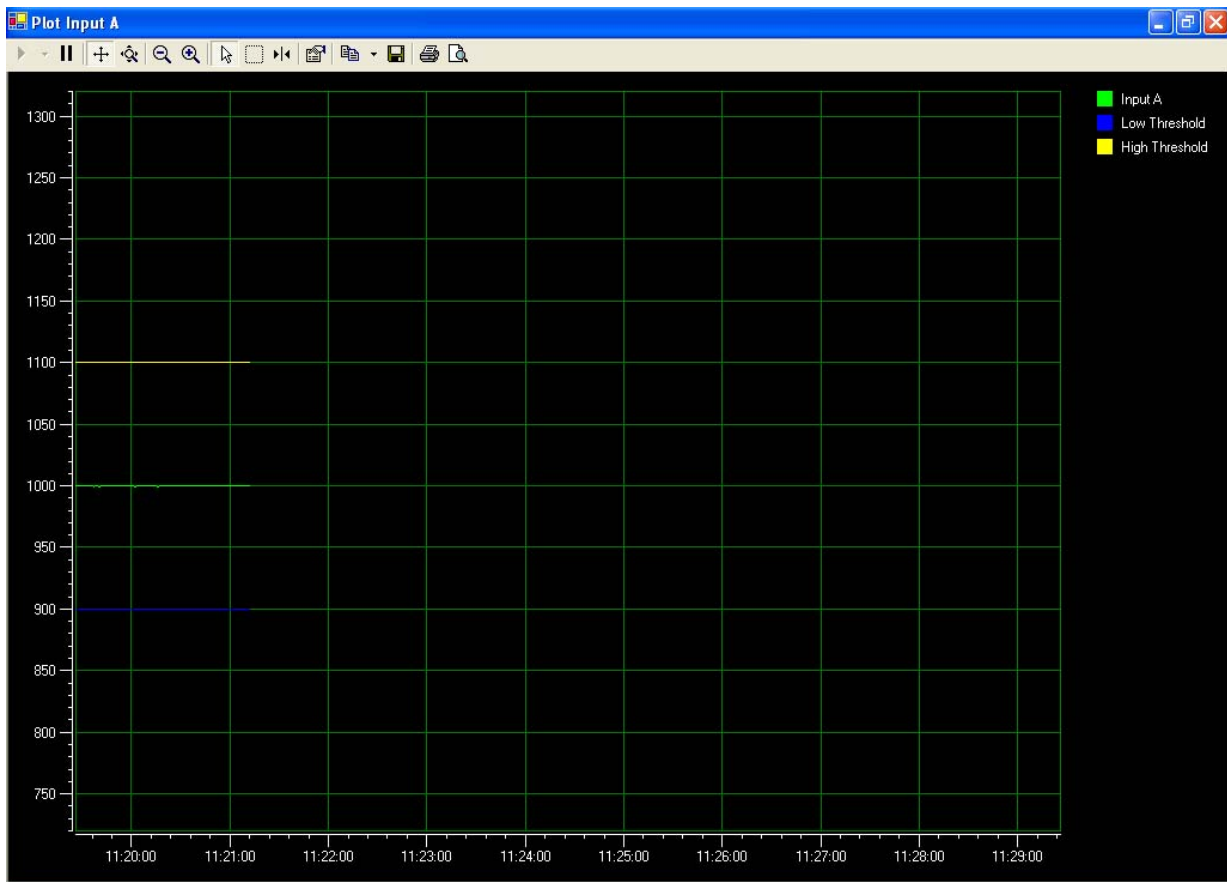

The plot below shows that at approximately 11:22 and 24 seconds, the speed increased to 1150. When a **Threshold** is breached, the color of the plot turns red.

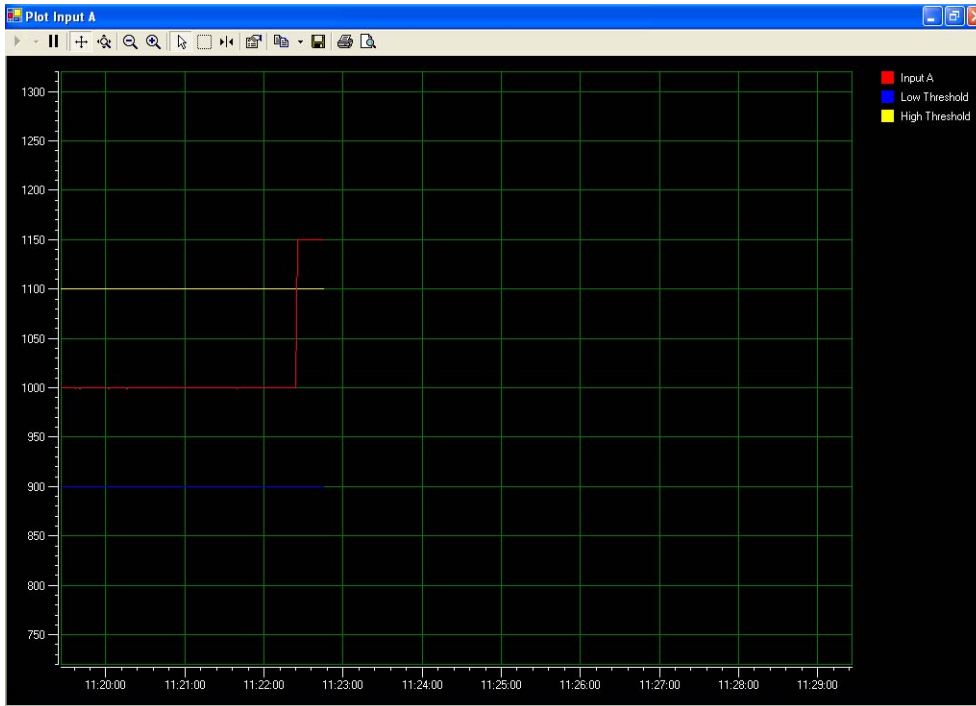

After approximately 66 seconds, at approximately 11:23 and 30 seconds, the signal returned to 1000 (between thresholds), then almost immediately dropped to 850, then back to 1000 in approximately 36 seconds.

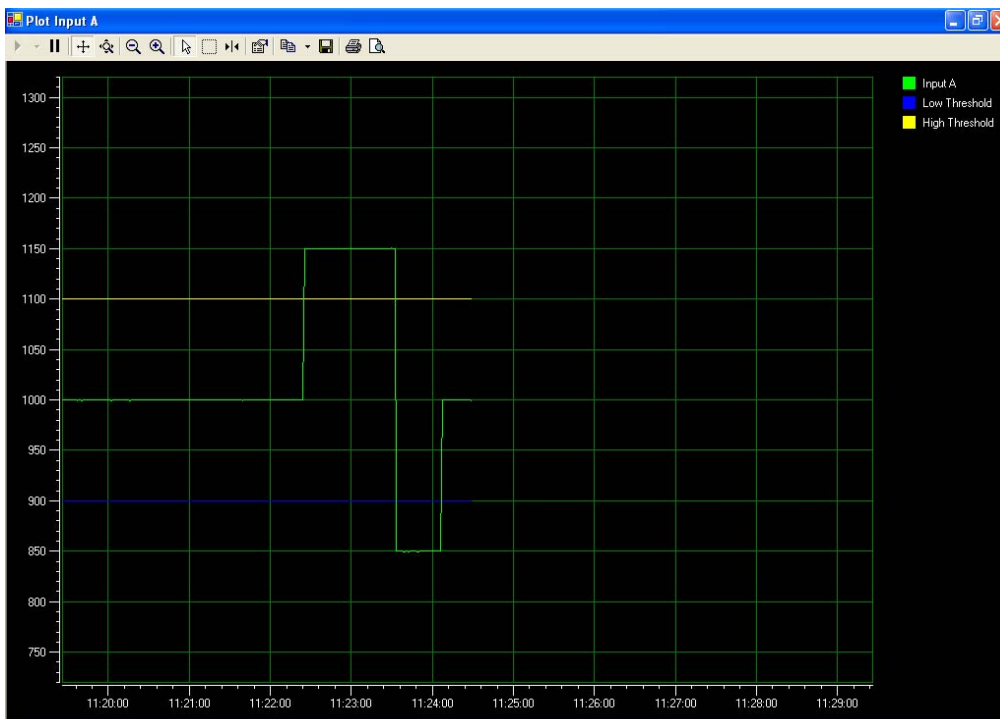

4.2.9.2.1. Plotting Toolbar

Above the plot screen is a toolbar to help manipulate the view. Most are standard Windows icons with familiar function.

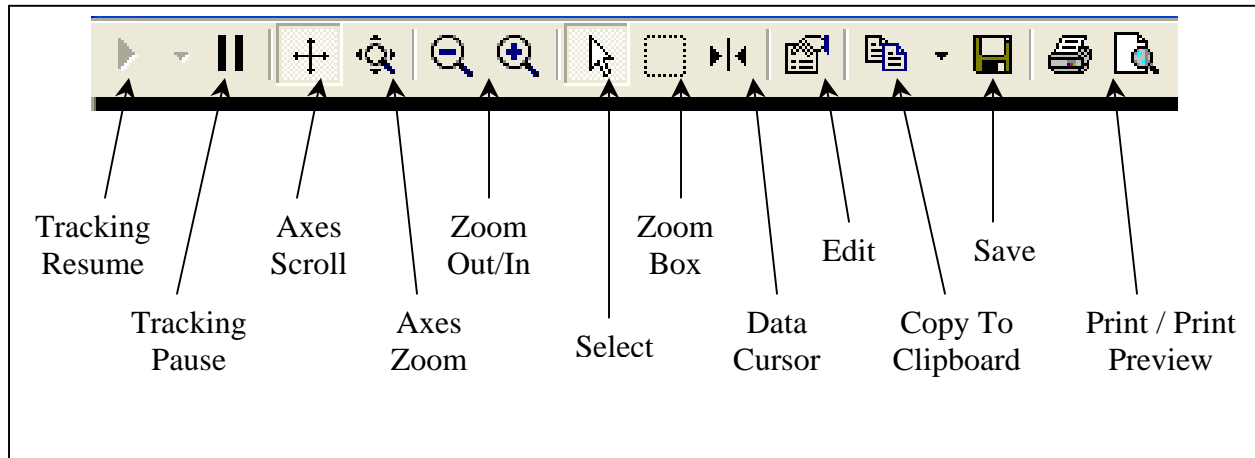

Tracking Resume: Use to continue tracking after it has been paused and to return all zoom, scroll and scaling changes back to nominal.

Tracking Pause: Once a plot has reached the full screen width, the screen will begin to track the plot as time moves forward. Pause allows the real time tracking to stop, however data will continue to accumulate and will be plotted once resumed.

Axes Scroll: Place the mouse pointer over the X or Y-axis and hold down the left mouse button. Moving up and down the axis moves it to show higher or lower values.

Axes Zoom: Place the mouse pointer over the X or Y-axis and hold down the left mouse button. Moving up and down the axis, expands and contracts it.

Zoom Out / In: Click on the appropriate magnifying glass to expand or contract the view.

Select: Place the mouse pointer over the X or Y-axis and hold down the left mouse button. Moving the mouse up/down changes the Y-axis while left to right changes the X-axis. Moving diagonally changes both axis simultaneously. Changes relate to the selection of either **Axes Scroll** or **Axes Zoom**.

Zoom Box: Place the mouse pointer near a section of interest, hold down the left mouse button and open a box. Release the button to zoom.

Data Cursor: Click on this icon to place a set of cross hairs over the plot. Move the finger pointer to the center of the cross-hair. Hold down the left mouse button to move the center of the cross-hair to a point of interest on the plot. The time and magnitude of the output will be displayed for that point. See Figure.

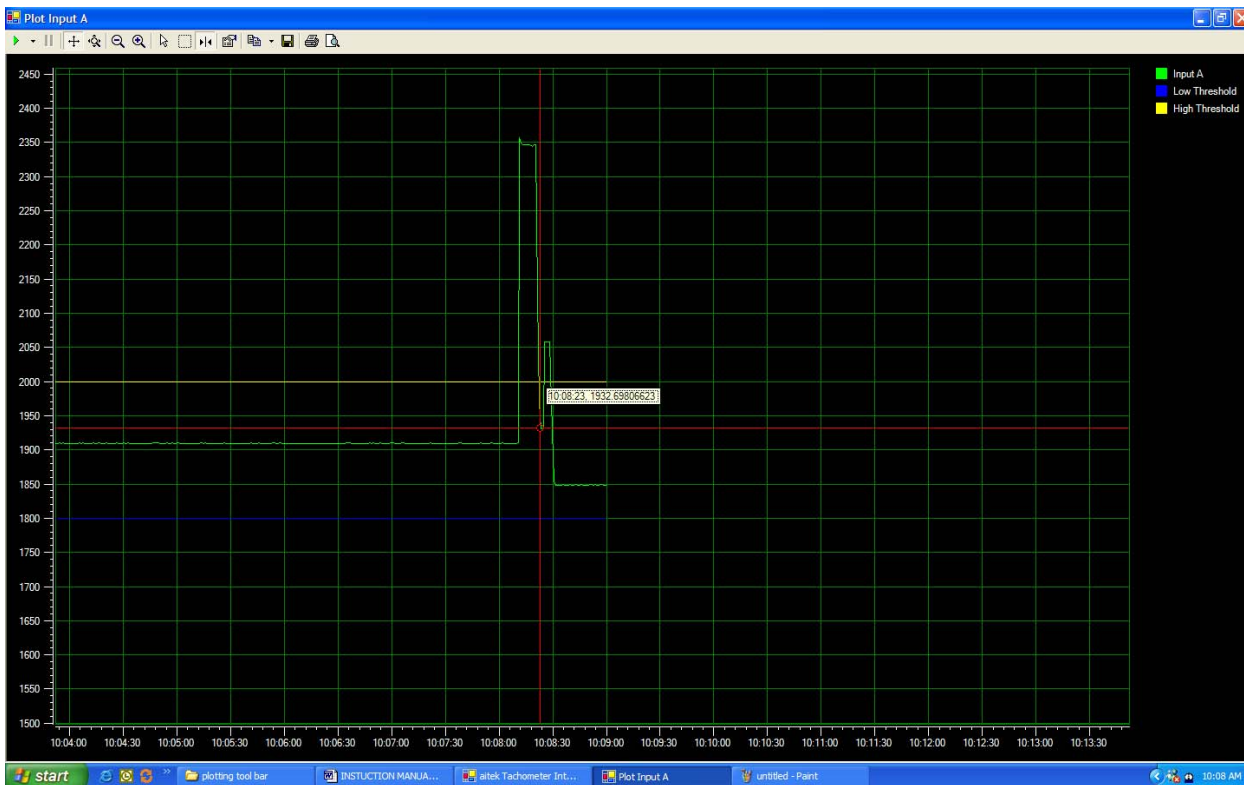

Edit: Allows the user to configure the look of the plotting screen.

Copy To Clipboard: Takes a screen shot of what is visible on the screen. The view can be pasted into a report based on Word, Excel, etc

Save: Allows the screen-shot to be saved to a specific file location.

Print/Print Preview: Allows the screen-shot to be viewed and printed.

When **Log To File** is checked during plotting, a spreadsheet is developed that contains critical data. It can be analyzed in its present form or imported into a program such as Excel to further manipulate the data. Below is the data file generated while producing the preceding plots. Since data is acquired every second, it has been truncated in this instance for the purpose of display. The complete record would have been several pages long. The data can be retrieved simply by going to the location it was saved, as defined in the file path in **Plotting Setup**

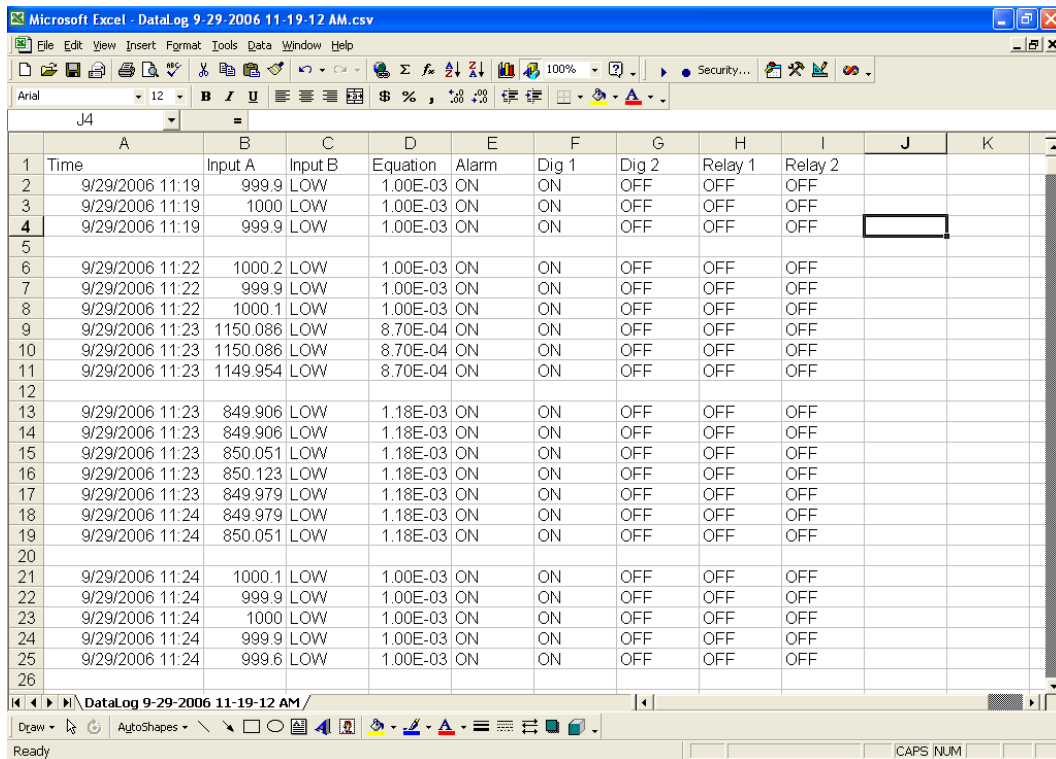

The screenshot shows a Microsoft Excel spreadsheet titled "DataLog 9-29-2006 11-19-12 AM.csv". The spreadsheet contains the following data:

	A	B	C	D	E	F	G	H	I	J	K
1	Time	Input A	Input B	Equation	Alarm	Dig 1	Dig 2	Relay 1	Relay 2		
2	9/29/2006 11:19	999.9	LOW	1.00E-03	ON	ON	OFF	OFF	OFF		
3	9/29/2006 11:19	1000	LOW	1.00E-03	ON	ON	OFF	OFF	OFF		
4	9/29/2006 11:19	999.9	LOW	1.00E-03	ON	ON	OFF	OFF	OFF		
5											
6	9/29/2006 11:22	1000.2	LOW	1.00E-03	ON	ON	OFF	OFF	OFF		
7	9/29/2006 11:22	999.9	LOW	1.00E-03	ON	ON	OFF	OFF	OFF		
8	9/29/2006 11:22	1000.1	LOW	1.00E-03	ON	ON	OFF	OFF	OFF		
9	9/29/2006 11:23	1150.086	LOW	8.70E-04	ON	ON	OFF	OFF	OFF		
10	9/29/2006 11:23	1150.086	LOW	8.70E-04	ON	ON	OFF	OFF	OFF		
11	9/29/2006 11:23	1149.954	LOW	8.70E-04	ON	ON	OFF	OFF	OFF		
12											
13	9/29/2006 11:23	849.906	LOW	1.18E-03	ON	ON	OFF	OFF	OFF		
14	9/29/2006 11:23	849.906	LOW	1.18E-03	ON	ON	OFF	OFF	OFF		
15	9/29/2006 11:23	850.051	LOW	1.18E-03	ON	ON	OFF	OFF	OFF		
16	9/29/2006 11:23	850.123	LOW	1.18E-03	ON	ON	OFF	OFF	OFF		
17	9/29/2006 11:23	849.979	LOW	1.18E-03	ON	ON	OFF	OFF	OFF		
18	9/29/2006 11:24	849.979	LOW	1.18E-03	ON	ON	OFF	OFF	OFF		
19	9/29/2006 11:24	850.051	LOW	1.18E-03	ON	ON	OFF	OFF	OFF		
20											
21	9/29/2006 11:24	1000.1	LOW	1.00E-03	ON	ON	OFF	OFF	OFF		
22	9/29/2006 11:24	999.9	LOW	1.00E-03	ON	ON	OFF	OFF	OFF		
23	9/29/2006 11:24	1000	LOW	1.00E-03	ON	ON	OFF	OFF	OFF		
24	9/29/2006 11:24	999.9	LOW	1.00E-03	ON	ON	OFF	OFF	OFF		
25	9/29/2006 11:24	999.6	LOW	1.00E-03	ON	ON	OFF	OFF	OFF		
26											

4.2.10. Display (TACHTROL series only)

While the function of the tachometer is defined by a set of global parameters stored in the tachometer instrument, each display can be configured uniquely to customize the content of what is seen at any given display. This configuration is stored locally at each display.

From the Main screen, depress **Menu**, , to list the Change menus.

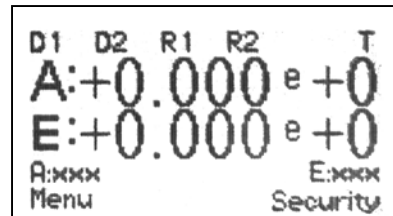

Depress  to select **Change Tach** menu.

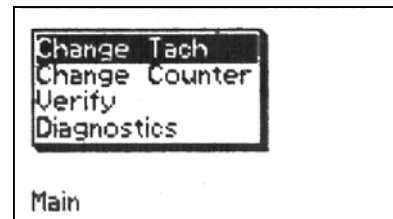

Use  to navigate to **Display / Keypad**. This selection is out of view until the user navigates past **Analog Output**.

Depress  to make the **Display / Keypad Setup** menu active.

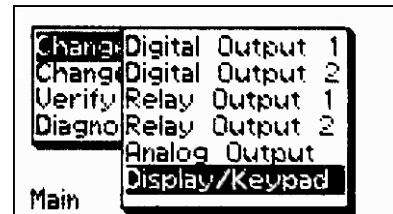

4.2.10.1. Display/Keypad Setup

The setup menu allows the user to determine what is displayed on **Line 1**, **Line 2**, if the display **Backlight** times out, and the **Contrast** of the display screen.

4.2.10.1.1. Display Line 1 & 2

Display Line 1 and **Line 2** correspond to lines on the display. In the figure shown, **Line 1** is displaying **A** and its data

while **Line 2** is displaying **E** and its data.

The user may select **Input A**, **B** or **Equation** to be displayed or turn off the line by selecting **Off**.

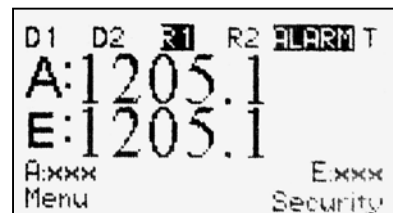

From the previous section and with **Display Line 1**

highlighted, depress **ENT** to toggle through **Input A**, **B** or **Equation** or **Off**. When the selection is made depress **ENT** to navigate to **Display Line 2**. Changes are made in the same manner as **Line 1**.

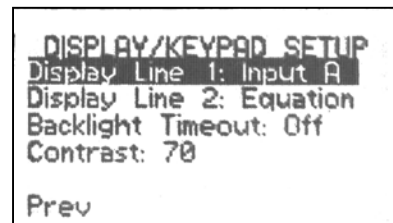

4.2.10.1.2. Backlight Timeout





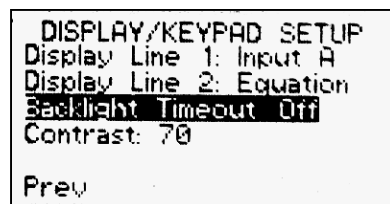

Off indicates there is no timer controlling the backlight and it will therefore stay on continuously. The backlight will automatically turn off after approximately 5 minutes when **On** is selected.

From the previous section depress **4** to navigate to **Backlight Timeout**. Depress **ENT** to toggle between **Off** and **On**.



4.2.10.1.3. Contrast

Adjusts the contrast between the displayed characters and the display background. Selectable from 50 (low) to 90 (high). User determines what is best for specific application lighting. 60 to 70 typically provides the best contrast range.

From the previous section depress  to navigate to **Contrast**. Depress  to make the constant active. Use  and  to increase or decrease the **Contrast** value. When complete, depress . When all changes are complete, depress **Prev**  and save changes as described in section 4.1.2.

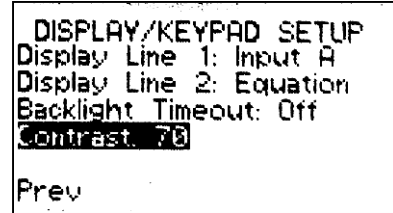

4.3. Infrared Remote

An IR remote is provided with all TACHTROL based explosion proof and NEMA 4X products and is also available as an accessory to all TACHTROL based tachometers. The IR remote allows full control of all front panel viewing and programming function. As long as line of sight can be established, the IR link will work through clear windows without the need to open the rated enclosures or establish direct contact with the front panel. Each key on the remote is mapped to the corresponding front panel keys. Programming is the same as described in the preceding sections.



The IR remote is common to all TACHTROL displays. When two displays are in close proximity, it is possible that both will receive commands simultaneously. Take precautions to ensure that only one display receives IR commands at a time. If this occurs, the system may lock up and power will need to be cycled on/off.

5. Example Applications

Below are some examples of typical or atypical applications, depending on your point of view. The first example shows what a simple tachometry application might look like while the second illustrates an application of moderate complexity including use of failsafe relay configuration. The third example is one that will utilize the tachometer instrument to its fullest. The sample applications are only to provide examples of how to use the capabilities of the new tachometers and are not meant as a guaranteed solution. It is up to the user to ensure the proper application of these instruments.

Startup Databases, retrievable through TACHLINK, contain configurations that utilize some of the more commonly used setups. By selecting one of the Databases, the constants are configured and may reduce the setup time and effort. Annex 1 (section 8) contains a table listing the Startup databases. See section 4.2.1.1 for how to retrieve them.

5.1. Basic setup

A pump shaft spins at a constant speed of 2000 rpm. A 4", 30 tooth, 8 Diametral pitch target is mounted to the shaft. The user wants to set the tachometer to alarm if the shaft speed drops below 1900 rpm and reset the alarm once the shaft speed returns to 1980 rpm. There is no requirement for an Overspeed alarm or a display.

5.1.1. Material Requirements

- 1 TACHPAK 10 (TP10): Use for speed
- 1 AI-TEK Passive Sensor

5.1.2. Connections

Instrument configuration can be done on the bench and tested using **Verify** and **Diagnostics**. Connections can then be made as follows:

- Connect power per section 3.4.2.
- Connect sensor to TP 10 per section 3.4.1.
- Connect alarm Relay 1 TP10 to speed alarm per section 3.3.1.

5.1.3. TACHPAK 10 Programming & Setup (rpm)

This instrument will be set to run in **Tachometer mode** and configured to monitor and report on the pump speed. No displays are in use and therefore programming can only be accomplished through TACHLINK.

Input Setup

5.1.3.1. Tachometer Mode (section 4.2.2)

All setup will be performed in Tachometer mode.

5.1.3.2. Direction (section 4.2.2.1)

Direction is set to off

5.1.3.3. Equation & Units (section 4.2.2.2)

No equation is being utilized and the instrument is set to react to the raw **A** input. No units are applied.

5.1.3.4. Logic Low & High(section 4.2.2.4)

Based on application calculations from the AI-TEK catalog, the sensor output will be approximately 6 volts peak to peak (3 vpk). Logic levels are adjustable and set as positive values. The values below are a suggestion and may be modified to adjust for noise issues.

Logic Low = 0.1 volts, High = 2.0 volts

5.1.3.5. Averaging(section 4.2.2.5)

Averaging will be used to help smooth out the speed.

- Averaging = On
- Average period (sec) = 0.5

5.1.3.6. Normalization (section 4.2.2.6.1)

In order for the instrument to display speed as RPM, the sensor frequency (pulses per second) must be normalized or mathematically altered to revolutions per minute (rpm).

- $(\text{pulses/sec}) \times (1 \text{ revolution}/30 \text{ pulses}) \times (60 \text{ seconds/min}) = 2 \text{ rpm}$
- Therefore, the input must be multiplied by 2 to read in rpm.
- **Normalization** is entered in exponential notation; **2.000 e+0**

5.1.3.7. Units (section 4.2.2.6.2)

Enter units as “rpm”

5.1.3.8. Input Type (section 4.2.2.6.3)

Select Frequency.

5.1.3.9. Min Freq(section 4.2.2.6.4)

Since it understood low frequency is not part of the normal operating condition of this application, set the min. frequency as high as possible to aid the tachometer in determining zero speed (stopped) condition sooner.

Min frequency = 100 Hz

Relay Output 1 Setup

5.1.3.10. Source (section 4.2.4.1)

Navigate back to Relay Output 1 setup. Select Input A for source.

5.1.3.11. Latch Mode (section 4.2.4.2.1)

Select Off

5.1.3.12. On / Off Delay (section 4.2.4.2.2)

No delay is desired. Enter 0.00 for both.

5.1.3.13. Output Switching (section 4.2.4.4.2)

Relay 1 is being used to ensure that speed does not drop below 1900 rpm.

- Select EB (energize below)
- Enter +1.900e+3 for the Alarm setpoint
- Enter +1.980e+3 for the Safe setpoint.

Digital 1 & 2, Relay 2 and Analog Output

None of these functions are being used and Source for each should be set to None.

Security Setup

No displays are in use. Therefore security is set on TACHLINK only.

5.1.3.14. Alarm Hold-Off (section 4.2.6.2)

Set to Off.

5.1.3.15. Keyboard Lock (section 4.2.6.3)

Set to **Locked**

5.1.3.16. Change Security Code (section 4.2.6.5)

Set the 8-digit security code using 1 through 4 keys.

5.1.4. Use Verify to validate setup (section 4.2.7)

5.2. Intermediate setup

A critical mixing operation must be monitored and maintained. A 4", 94 tooth, 24 diametral pitch target is mounted to the mixer driveshaft. The user wants to be able to visually see the speed displayed in RPM, and have a 4-20mA output scaled to the speed range. The user also needs to set up 4 alarms. Alarm 1 & 2 must be failsafe and therefore will utilize the mechanical relays with Normally Closed contacts. Alarm 3 & 4 will be set for over and under speed and will utilize the Digital outputs. Over and under speed alarm setpoints are 300 and 400 RPM respectively with 50 RPM hysteresis. The failsafe limits are 10% beyond the normal setpoints (270 and 440 respectively) with 80 RPM hysteresis for under speed and 90 RPM for over speed. A remote display is required for a control room.

5.2.1. Material Requirements

1 TACHTROL 30 (TT30): Use for speed with display and analog output requirement

1 TACHTROL^{plus} (TT^{plus}): Use as remote display for tachometer instruments

1 AI-TEK Single Channel Hall Effect Sensor

5.2.2. Connections

Instrument configuration can be done on the bench and tested using **Verify** and **Diagnostics**. Connections can then be made as follows:

- Connect power per **section 3.4.2**.
- Connect TACHTROL^{plus} remote display to TACHTROL 30 per **section 3.3.2 and 3.3.3**.
- Connect sensor to TACHTROL 30 per **section 3.4.1**.
- Connect Analog output per **section 3.3.2**.
- Connect alarm Relay 1 & 2 from TT30 (normally closed contacts) to failsafe alarm per **section 3.3.2**.
- Connect alarm Digital 1 & 2 from TT30 to speed alarm per **section 3.3.2**.

5.2.3. TACHTROL 30 Programming & Setup (Speed)

This instrument will be set to run in **Tachometer mode** and configured to monitor and report on speed of the mixer. Programming can be accomplished either through the TT display or TACHLINK.

Input Setup

5.2.3.1. Tachometer Mode (section 4.2.2)

All setup will be performed in Tachometer mode.

5.2.3.2. Direction (section 4.2.2.1)

Direction is not utilized, set to None.

5.2.3.3. Equation & Units (sections 4.2.2.2 and 4.2.2.3)

No equation is being utilized and the instrument is set to react to the raw **A** input. No units are applied.

5.2.3.4. Logic Low & High(section 4.2.2.4)

Logic Low = 0.6 volts, High = 2.6 volts (TTL)

5.2.3.5. Averaging(section 4.2.2.5)

Averaging will not be used.

- Averaging = Off
- Average period (sec) = 0.00

5.2.3.6. Normalization (section 4.2.2.6.1)

In order for the instrument to display speed as RPM, the sensor frequency (pulses per second) must be normalized or mathematically altered to revolutions per minute (rpm).

- $(\text{pulses/sec}) \times (1 \text{ revolution}/94 \text{ pulses}) \times (60 \text{ seconds/min}) = 0.6383 \text{ rpm}$
- Therefore, the input must be multiplied by 0.6383 to read in rpm.
- **Normalization** is entered in exponential notation; **6.383 e-1**

5.2.3.7. Units (section 4.2.2.6.2)

Enter units as “RPM”

5.2.3.8. Input Type (section 4.2.2.6.3)

Select Frequency.

5.2.3.9. Min Freq (section 4.2.2.6.4)

Min frequency = 0.100

Digital Output 1 Setup (Over speed alarm)

5.2.3.10. Source (section 4.2.4.1)

Navigate back to Digital Output 1 setup. Select Input A for source.

5.2.3.11. Latch Mode (section 4.2.4.2.1)

Select Off

5.2.3.12. On / Off Delay (section 4.2.4.2.2)

No delay is desired. Enter 0.00 for both.

5.2.3.13. Output Switching (section 4.2.4.4.1)

Digital 1 is being used to ensure that the speed does not exceed 400 rpm.

- Select EA (energize above)
- Enter 4.000e+2 for the Alarm setpoint.
- Enter 3.500e+2 for the Safe setpoint.

Digital Output 2 Setup

Navigate to Digital Output 2 setup. Make all constants the same except for Output switching.

5.2.3.14. Output Switching (section 4.2.4.4.2)

Digital 1 is being used to ensure that the speed does not drop below 300 rpm.

- Select EB (energize below)
- Enter +3.000e+2 for the Alarm setpoint
- Enter 3.500e+2 for the Safe setpoint.

Relay Output 1 Setup (Failsafe Overspeed alarm)

5.2.3.15. Source (section 4.2.4.1)

Navigate back to Relay Output 1 setup. Select Input A for source.

5.2.3.16. Latch Mode (section 4.2.4.2.1)

Select Off

5.2.3.17. On / Off Delay (section 4.2.4.2.2)

No delay is desired. Enter 0.00 for both.

5.2.3.18. Output Switching (section 4.2.4.4.3)

Relay 1 is being used as failsafe for speeds in excess of 440 rpm.

- Select DA (de-energize above)
- Enter 4.400e+2 for the Alarm setpoint.
- Enter 3.500e+2 for the Safe setpoint.

Relay Output 2 Setup(Failsafe Underspeed alarm)

Navigate to Digital Output 2 setup. Make all constants the same except for Output switching.

5.2.3.19. Output Switching (section 4.2.4.4.4)

Relay 2 is being used as failsafe for speeds below 270 rpm.

- Select DB (de-energize below)
- Enter +2.700e+2 for the Alarm setpoint
- Enter 3.500e+2 for the Safe setpoint.

Analog Output Setup

Navigate to the Analog output section. 4 to 20 mA will be used. 20mA will be the max speed, 4mA will be for min speed.

5.2.3.20. Source (section 4.2.5.1.1)

Set source to Input A.

5.2.3.21. Range (section 4.2.5.1.2)

Set range to 4 to 20 mA.

5.2.3.22. Min / Max Value (section 4.2.5.1.3)

Set the maximum and minimum values of the speed range to monitor. In this case speed beyond the failsafe range will be included

- Min Value = +2.000e+2 (200 rpm)
- Max Value = +5.000e+2 (500 rpm)

Security Setup

5.2.3.23. Alarm Hold-Off (section 4.2.6.2)

Set to Off.

5.2.3.24. Keypad Lock (section 4.2.6.3)

Keypad lock is local to each display and must be set to **Locked** in order to protect the keypad from changes. Each display must be either Locked or Unlocked individually.

5.2.3.25. Display Address(section 4.2.6.4)

Each display must have its own address on the LAN. Set each display to a different number.

5.2.3.26. Change Security Code (section 4.2.6.5)

Set the 8-digit security code using 1 through 4 keys.

Display Setup

The user requires that the displays show only the displacement (normalized input A) and wants the backlight to stay on. Navigate to Display / Keypad Setup.

5.2.3.27. Display Line 1 & 2(section 4.2.10.1.1)

Set Line 1 to Input A, Line 2 to Off.

5.2.3.28. Backlight Timeout (section 4.2.10.1.2)

Set Timeout to Off (will stay on continuously).

5.2.3.29. Contrast (section 4.2.10.1.3)

Contrast = 70

5.2.4. Use Verify to validate setup (section 4.2.7)

5.3. Advanced Setup

5.3.1. Problem Description

A motor used to drive a lead-screw attached to a linear stage used in a manufacturing process must be monitored. The motor will rotate both clockwise (cw) and counterclockwise (ccw) in normal use. It is important to know how fast the linear speed of the stage is as well as its direction. The user also wants to be able to determine the stages' displacement and have alarms set to indicate if displacement has exceeded 4 inches from "home" in either direction. Once the stage has moved more than 4 inches, an alarm will be triggered and will not reset until the stage has moved to back to 3.75 inches. There is also an Overspeed alarm used to trigger an alarm if the linear speed of the stage exceeds 1 inch per minute and will not reset until the speed has dropped below 0.9 inches per minute. There is a 4", 94-tooth target mounted to the motor shaft. The lead-screw will move the stage 1" for every 1000 turns of the motor.

The application requires four displays, two mounted together near the machinery; one indicating linear speed (inches/minute) of the stage and the other displacement (inches). The remaining two displays will indicate the same as the first two, but are mounted in a remote location. Alarms are required for both the speed and displacement and the analog output will be used to monitor speed and drive a proprietary circuit developed by the user.

Because of the location of the displays, security is a requirement to protect against unwanted changes and alarm resets.

Two tachometers are required for this application. One will run in Counter mode to determine displacement, the other in Tachometer mode for speed.

5.3.2. Material Requirements

1 TACHTROL 30 (TT30): Use for speed with analog output requirement

1 TACHTROL 10 (TT10): Use for displacement

2 TACHTROL^{plus} (TT^{plus}): Use as remote displays for tachometer instruments

1 AI-TEK Bi-Directional Sensor (Shown for illustrative purposes. Use encoder where a high level of precision is required.

5.3.3. Connections

Instrument configuration can be done on the bench and tested using **Verify** and **Diagnostics**. Connections can then be made as follows:

- Connect power per **section 3.4.2**.
- Connect TACHTROL^{plus} remote displays to TACHTROL 10 and 30 per **section 3.3.2 and 3.3.3..**
- Connect sensor to TACHTROL 10 and 30. Parallel A Sig, B Sig and Direction logic terminations as well as common per **section 3.3.2**.
- Connect Analog output per **section 3.3.2**.
- Connect alarm Relay 1 & 2 from TT10 to speed alarm per **section 3.3.2**.
- Connect alarm Digital 1 & 2 from TT30 to displacement alarm per **section 3.4.2**.

5.3.4. TACHTROL 10 Programming & Setup (Displacement)

This instrument will be set to run in **Counter mode** and configured to monitor and report on the displacement of the stage. Since the stage will be moving in two directions, direction mode will be employed to track the increase and decrease of pulses generated by the sensor, that translate into the relative motion of the stage. Programming can be accomplished either through the TT display or TACHLINK.

Input Setup

5.3.4.1. Counter Mode (section 4.2.3)

All setup will be performed in Counter mode.

5.3.4.2. Direction (section 4.2.3.1)

Direction is utilized to allow the instrument to increase counts in a forward (target cw) direction and decrease counts in a reverse (target ccw) direction. Since an AI-TEK Bi-directional sensor is being used, the direction logic signal will be utilized. The instrument will be set to count up in the forward (target cw) direction with the **Direction Bit High**.

5.3.4.3. Equation & Units (section 4.2.3.1)

No equation is being utilized and the instrument is set to react to the raw **A** input. No units are applied.

5.3.4.4. Logic Low & High(section 4.2.3.2)

Logic Low = 0.6 volts, High = 2.6 volts (TTL)

5.3.4.5. Normalization (section 4.2.3.3)

In order for the instrument to display and react to linear displacement of the stage, the motor rotation (pulses per revolution) must be normalized or mathematically altered to linear units (inches).

- (94 pulses/revolution) x (1000 revolutions/inch)= 94,000 pulses/inch
- Therefore the input must be divided by 94,000 or multiplied by 1/94,000 (0.00001064) to read in inches.
- **Normalization** is entered in exponential notation. 0.0000106 = **1.064 e-5**

5.3.4.6. Units(section 4.2.3.4)

Enter units as "Inches"

5.3.4.7. Counter Type (section 4.2.3.5)

Select Up

5.3.4.8. Preset (section 4.2.3.6)

No preset is required. Set to 0.000e+0

Relay Output 1 Setup

5.3.4.9. Source (section 4.2.4.1)

Navigate back to Relay Output 1 setup. Select Input A for source.

5.3.4.10. Latch Mode (section 4.2.4.2.1)

Select Off

5.3.4.11. On / Off Delay (section 4.2.4.2.2)

No delay is desired. Enter 0.00 for both.

5.3.4.12. Output Switching (section 4.2.4.4.1)

Relay one is the first of two displacement alarms to be set and will monitor when the stage has moved greater than 4 inches in the positive direction.

- Select EA (energize above)
- Enter 3.750e+0 for the Safe setpoint.
- Enter 4.000e+0 for the Alarm setpoint.

Relay Output 2 Setup

Navigate to Relay Output 2 setup. Make all constants the same except for Output switching.

5.3.4.13. Output Switching (section 4.2.4.4.2)

- Select EB (energize below)
- Enter -4.000e+0 for the Alarm setpoint
- Enter -3.750e+0 for the Safe setpoint.

Digital Output 1 & 2 and Analog Output Setup

None of these functions are being used and Source for each should be set to None.

Security Setup

5.3.4.14. Alarm Hold-Off (section 4.2.6.2)

Set to Off.

5.3.4.15. Keypad Lock (section 4.2.6.3)

Keypad lock is local to each display and must be set to **Locked** in order to protect the keypad from changes. Each display must be either Locked or Unlocked individually.

5.3.4.16. Display Address(section 4.2.6.4)

Each display must have its own address on the LAN. Set each display to a different number.

5.3.4.17. Change Security Code (section 4.2.6.5)

Set the 8-digit security code using 1 through 4 keys.

Display Setup

The user requires that the displays show only the displacement (normalized input A) and wants the backlight to stay on. Navigate to Display / Keypad Setup.

5.3.4.18. Display Line 1 & 2(section 4.2.10.1.1)

Set Line 1 to Input A, Line 2 to Off.

5.3.4.19. Backlight Timeout (section 4.2.10.1.2)

Set Timeout to Off (will stay on continuously).

5.3.4.20. Contrast (section 4.2.10.1.3)

Contrast = 70

5.3.5. TACHTROL 30 Programming & Setup (Speed)

This instrument will be set to run in **Tachometer mode** and configured to monitor and report on the linear speed of the stage. Since the stage will be moving in two directions, direction mode will be employed to track the speed in both the forward and reverse motion of the stage. Programming can be accomplished either through the TT display or TACHLINK.

Input Setup

5.3.5.1. Tachometer Mode (section 4.2.2)

All setup will be performed in Tachometer mode.

5.3.5.2. Direction (section 4.2.2.1)

Direction is utilized to allow the instrument to increase positive speed in a forward (target cw) direction and decrease speed in a reverse (target ccw) direction. Since an AI-TEK Bi-directional sensor is being used, the direction logic signal will be utilized. The instrument will be set to increase positive speed in the forward (target cw) direction with the **Direction Bit High**.

5.3.5.3. Equation & Units (sections 4.2.2.2 and 4.2.2.3)

No equation is being utilized and the instrument is set to react to the raw **A** input. No units are applied.

5.3.5.4. Logic Low & High(section 4.2.2.4)

Logic Low = 0.6 volts, High = 2.6 volts (TTL)

5.3.5.5. Averaging(section 4.2.2.5)

Averaging will be used to help smooth out the speed reading.

- Averaging = On
- Average period (sec) = 0.5

5.3.5.6. Normalization (section 4.2.2.6.1)

In order for the instrument to display and react to linear speed of the stage, the motor rotation (pulses per second) must be normalized or mathematically altered to linear units (inches) per minute.

- $(1 \text{ revolution}/94 \text{ pulses}) \times (1 \text{ inch}/1000 \text{ revolutions}) \times (60 \text{ seconds}/\text{min}) = .0006383 \text{ inches}/\text{min}$
- Therefore the input must be multiplied by .0006383 to read in inches/min.
- **Normalization** is entered in exponential notation. $0.0006383 = 6.383 \text{ e-4}$

5.3.5.7. Units (section 4.2.2.6.2)

Enter units as “Inches/Sec”

5.3.5.8. Input Type (section 4.2.2.6.3)

Select Frequency.

5.3.5.9. Min Freq(section 4.2.2.6.4)

Min frequency = 0.100

Digital Output 1 Setup

5.3.5.10. Source (section 4.2.4.1)

Navigate back to Digital Output 1 setup. Select Input A for source.

5.3.5.11. Latch Mode (section 4.2.4.2.1)

Select Off

5.3.5.12. On / Off Delay (section 4.2.4.2.2)

No delay is desired. Enter 0.00 for both.

5.3.5.13. Output Switching (section 4.2.4.4.1)

Digital 1 is being used to ensure that the linear speed does not exceed 1 inch per minute in the forward (positive) direction.

- Select EA (energize above)
- Enter 1.000e+0 for the Alarm setpoint.
- Enter 9.000e-1 for the Safe setpoint.

Digital Output 2 Setup

Navigate to Digital Output 2 setup. Make all constants the same except for Output switching.

5.3.5.14. Output Switching (section 4.2.4.4.2)

Digital 2 is being used to ensure that the linear speed does not exceed 1 inch per minute in the reverse (negative) direction

- Select EB (energize below)
- Enter -1.000e+0 for the Alarm setpoint
- Enter -9.000e-1 for the Safe setpoint.

Relay Output 1 & 2

None of these functions are being used and Source for each should be set to None.

Analog Output Setup

Navigate to the Analog output section. -20 to +20 mA will be used. 20mA will be the max forward speed, 0mA will be stationary and -20 will be max reverse speed.

5.3.5.15. Source (section 4.2.5.1.1)

Set source to Input A.

5.3.5.16. Range (section 4.2.5.1.2)

Set range to -20 to +20 mA.

5.3.5.17. Min / Max Value (section 4.2.5.1.3)

Set the maximum and minimum values of the speed range to monitor.

- Min Value = -1.000e+0
- Max Value = +1.000e+0

Security Setup

5.3.5.18. Alarm Hold-Off (section 4.2.6.2)

Set to Off.

5.3.5.19. Keypad Lock (section 4.2.6.3)

Keypad lock is local to each display and must be set to **Locked** in order to protect the keypad from changes. Each display must be either Locked or Unlocked individually.

5.3.5.20. Display Address(section 4.2.6.4)

Each display must have its own address on the LAN. Set each display to a different number.

5.3.5.21. Change Security Code (section 4.2.6.5)

Set the 8-digit security code using 1 through 4 keys.

Display Setup

The user requires that the displays show only the displacement (normalized input A) and wants the backlight to stay on. Navigate to Display / Keypad Setup.

5.3.5.22. Display Line 1 & 2(section 4.2.10.1.1)

Set Line 1 to Input A, Line 2 to Off.

5.3.5.23. Backlight Timeout (section 4.2.10.1.2)

Set Timeout to Off (will stay on continuously).

5.3.5.24. Contrast (section 4.2.10.1.3)

Contrast = 70

5.3.6. Use Verify to validate setup (section 4.2.7)

6. Specifications

Specifications in this manual are subject to change and for reference only. See applicable AI-TEK Instruments, LLC Product Specifications.

Electrical

All specifications rated at 25°C unless otherwise specified.

Input Power

Power consumption

3.5 watts, typical for tachometer only

Add 0.5 watts per remote display

Add 2.0 watts for 12v out

DC Voltage

12-30 volts. Reverse polarity protected. Available on terminal blocks and din rail in parallel (TACHPAK only).

AC Voltage

80-264 Vac 50-60 Hz

Power Sharing

If DC input and AC input are both supplied, DC will be loaded above approximately 15 volts. Below 15VDC input, AC will be loaded.

Output Power

Regulated to 12 volts @ 150mA when input voltage is 13.6 volts and above.

Below 13.6 volts output voltage \approx input voltage – 1.5V.

Input Signal Characteristics

Channel A & B

Frequency

Upper Limit: 50 kHz absolute max. (20 microsecond period); 40kHz typical.

Lower Limit: 0.005 Hz absolute min. (200 sec. Period); 0.05Hz typical

Minimum Pulse Width: 0.5 μ sec.

Wave shape: Square or Sinusoidal

Input Impedance

12 k Ω typical

Input Sensitivity

Upper and Lower Limit: +/-30 volts max. (AC or DC). Logic 0 and Logic 1 threshold is user adjustable from 0 to 28 volts in approx. 20mV steps +/-3%. 200 mV pk absolute minimum input sensitivity.

Common Mode Rejection Ratio

>40 db @ 1kHz typical

Electrical Isolation

Channel A, B and Direction share common ground
Channel A , B or Direction to output: 500 Vrms
Channel A , B or Direction to power ground: 500 Vrms

Verify and Reset

Frequency

Essentially DC, Minimum Pulse Width: 250 μ sec.

Input Impedance

10mA current regulated

Input Sensitivity

3.5 volts min. between input and return, 40 volts max.

Common Mode Rejection Ratio

>40 db @ DC typical

Electrical Isolation

Signal to signal 500 Vrms
Signal to ground 500 Vrms

Direction

Frequency

Essentially DC
Minimum Pulse Width: 0.5 μ sec.

Input Impedance

12 k Ω typical

Input Sensitivity

Upper and Lower Limit: +/-30 volts max. (AC or DC). Logic 0 and Logic 1 threshold is user adjustable from 200mV to +28 volts in approx. 20mV steps +/-3%.

Common Mode Rejection Ratio

>40 db @ 1kHz typical

Electrical Isolation

Channel A, B and Direction share common ground

Direction to output: 500 Vrms

Direction to ground: 500 Vrms

Output Characteristics

Relays (Mechanical)

Physical

Form C

Contact Rating

10A @ 125/250 Vac, 6A @ 277 Vac, 5A @ 100Vdc

2500 VA

Response Time (operate and release)

Input to output 16.5 msec max. (10msec relay only)

Electrical Isolation

1500 Vrms, 1 minute coil to contacts

Switchpoint Accuracy

Internal instrument accuracy to alarm setpoint: .005% up to 16kHz, .016% at 50kHz

Relays (Solid State)

Physical

Form A

Contact Rating

400mA @ 60V (AC or DC)

On resistance: 2 Ω max

Response Time (operate and release)

Operate: 2 ms max, 0.8 ms typical

Release: 0.5 ms max, 0.1 ms typical

Electrical Isolation

500 Vrms, 1 minute

Switchpoint Accuracy

Internal instrument accuracy to alarm setpoint: .005% up to 16kHz, .016% at 50kHz

Analog Output

Ranges

0 to 20mA, 4 to 20mA, -20 to +20mA; user selectable

Accuracy

Internal instrument accuracy: .005% plus;

0.05% of full scale range at room temp with 400 ohm load

0.1% over temp range and load range.

Unit is factory calibrated. Can be re-calibrated using TACHLINK.

Resolution

Step size: 610 nanoamps per lsb. 16 bit D/A

Linearity

0.02% typical

Loop Impedance

100-1000 Ω

Response Time

Input to output 6.55 msec+ 1 msec settle at 1k Ω (worst case) to .1% of final value

Electrical Isolation

500 Vrms volt continuous

Display (applies to both remote and integrated displays)

Resolution

Black and White graphics display. 64x128 Pixels.

Accuracy

0.05% of full scale

Communication Protocol

RS485: 19.2kbaud, 8-n-1 protocol, Half duplex, Tachometer is bus master

Network

Multiplex up to seven displays plus one integrated display. Displays are addressable.

With all seven displays at the end of one RJ11 6-4 cable, max length would be 125 ft (38m), limited by voltage drop in cable. Cable must be 1:1 type (not flipped), described as RJ11 6-4 reversed cable. For longer distances the RJ type

cable should not be used. With #18 wire max run to a single display is 1000 ft (305m).

Response time: 1 second update to all displays, PC, and RS485

Electrical Isolation

500Vrms to ground continuous

Utility RS485

Full access to TACHLINK, single drop only

Communication Protocol

RS485: 19.2kbaud, 8-n-1 protocol, Half duplex, Tachometer is bus master

Maximum Transmission Distance

8000 ft (2400m)

Electrical Isolation

500Vrms to ground continuous

USB

Full access to TACHLINK,
Version 1.1 / 2.0 compatible
B type jack on Tachometer

Processing Platform

PIC18F series micro controller

Clock Speed

10mhz, +/-50 ppm at room temp

Acquisition Time

Basic instrument acquisition time / period 6.55 milliseconds

Accuracy

Basic instrument accuracy +/- .005% (50 ppm). Above 16kHz, .016%.

Resolution

Basic instrument resolution: +/- .025% or better

Environmental

Operating Temperature

-10 to 55°C

Thermal Cycle

50 cycles: -40°C to +80°C

200 cycles: -10°C to +55°C

Dielectric Strength

See applicable Specifications sub-sections

Humidity

90% RH non-condensing per IEC 654-1, IEC 68-2-3

Vibration

- MIL-STD-810C Environmental Test Methods, method 514.2, procedure VIII, figure 514.2-6, curve V; 1.5g's 10-2000Hz, 5.5 hrs. / axis, 3 axis
- IEC 60068-2-6, 10-150Hz, 2g, 10 sweep cycles / axis, 3 axis

Shock

- MIL-STD-810C Environmental Test Methods, method 516.2, procedure I and figures 516.2-2, for ground equipment; 30g's half sine, 11mS, 3 axis, 18 total
- IEC 60068-2-27; 50g half sine, 11mS, 3 axis, 18 total

EMC

EN 61326:1997 Class A radiated and conducted emissions with amendments A1, A2 and A3

EN 61326:1997 with amendments A1, A2 and A3, Immunity

EN 61000-4-2:1998 Electrostatic Discharge: ±4kV contact, ±8kV air

EN 61000-4-3:1998 Radiated Immunity: 10V/m

EN 61000-4-4:1995 Electrical Fast Transients/Burst: ±2kV AC, ±1kV I/O > 3m

EN 61000-4-5:1995 Surges: ±1kV differential mode, ±2kV common mode, ±1kV line to ground I/O > 30m

EN 61000-4-6:1996 Conducted Immunity: 3V

EN 61000-4-11:1994 Supply Dips and Variations: 100%, 0.5 cycle each polarity

RoHS

RoHS compliant per European Directive 2002/95/EC

7. Target Variable Conversions

$$f = \frac{\text{RPM} \times \text{PPR}}{60} = \frac{\text{ss} \times \text{PPR}}{\pi \times D}$$

$$f = \frac{\text{UPM} \times \text{PPU}}{60} = \frac{\text{UPH} \times \text{PPU}}{3600}$$

$$\text{ss} = \frac{\text{RPM} \times \pi \times D}{60} = \frac{f \times \pi \times D}{\text{PPR}}$$

$$\text{RPM} = \frac{60 \times f}{\text{PPR}} = \frac{60 \times \text{ss}}{\pi \times D}$$

$$D = \frac{(\text{PPR} + 2)}{\text{DP}} = \frac{\text{ss} \times \text{PPR}}{f \times \pi}$$

$$\text{DP} = \frac{(\text{PPR} + 2)}{D} = \frac{25.4}{M}$$

$$M = \frac{25.4}{\text{DP}} = \frac{25.4 \times D}{(\text{PPR} + 2)}$$

$$\text{PPR} = (D \times \text{DP}) - 2 = \frac{60 \times f}{\text{RPM}} = \frac{f \times \pi \times D}{\text{ss}}$$

Definitions:

f = frequency in Hz or cycles per second (cps)

ss = surface speed in inches per second (ips)

RPM = rotary speed in revolution per minute

PPR = pulses per revolution or number of gear teeth

D = outside diameter of target (gear) in inches

π = 3.14

UPM = unit measure per minute

UPH = unit measure per hour

PPU = pulses per unit measure

DP = diametral pitch = number of teeth in 1 inch pitch diameter

M = metric module = pitch diameter in mm \div number of gear teeth

8. Annex 1: Startup Databases

Access the following databases through TACHLINK as described in section 4.2.1.1.

Tachometer Mode							
Tachpak/Tachtrol 30							
Data Base Name	Analog Output			Relay Output			
	(AO0) 0-20	(AO4) 4-20	(AO20) -20+20	D1	D2	R1	R2
T30-AO0	x						
T30-AO4		x					
T30-AO20			x				
T30-AO4D1		x		x			
T30-AO4R1		x				x	
T30-AO4D1D2R1R2		x		x	x	x	x
T30-D1				x			
T30-R1						x	
T30-D1D2R1R2				x	x	x	x
Tachpak/Tachtrol 10							
T10-R1						x	
T10-R1R2	N/A					x	x
Counter Mode							
Tachpak/Tachtrol 30							
C30-AO0	x						
C30-AO4		x					
C30-AO20			x				
C30-AO4D1		x		x			
C30-AO4R1		x				x	
C30-AO4D1D2R1R2		x		x	x	x	x
C30-D1				x			
C30-R1						x	
C30-D1D2R1R2				x	x	x	x
Tachpak/Tachtrol 10							
C10-R1						x	
C10-R1R2	N/A					x	x
Example database file name: T30-AO4D1D2R1R2 = TACH mode, 30 series, 4-20mA, all relays							

9. Warranty and Return Shipments Statement

The materials ordered and agreed to be furnished by Seller are warranted against defect of material or workmanship for a period of (1) year from the date of shipment, or for their rated life (whichever period ends first). Seller's obligation under the warranty is limited to repair or replacement, in Seller's option, of the defective material at Seller's factory (point of shipment) and does not extend to equipment other than of Seller's factory (point of shipment) and does not extend to equipment other than of Seller's manufacture. The warranty shall not apply to any product or part which has been subject to misuse, negligence, accident, or attempted or unauthorized repair or modification. All return shipments must be factory authorized prior to shipment, and shipment will be at buyer's expense. The only statutory warranties applicable to the materials are warranties of title and that the materials will be merchantable and, if manufactured to Buyer's specifications, that the said items conform to such specifications. UNLESS EXPRESSLY STATED ON THE FACE HEREOF, NO WARRANTY OF FITNESS FOR ANY PARTICULAR PURPOSE IS TO BE IMPLIED, NOR ARE ANY OTHER WARRANTIES WHICH EXTEND BEYOND THOSE STATED HEREIN. SELLER'S SOLE LIABILITY FOR DEFECTS OR BREACH OF WARRANTY SHALL BE REPLACEMENT OF THE MATERIALS INVOLVED, AND IN NO EVENT WILL THE SELLER BE LIABLE FOR SPECIAL OR CONSEQUENTIAL DAMAGES. FAILURE TO TEST, INSPECT AND MAKE CLAIMS FOR BREACH OF WARRANTY WITHIN REASONABLE PERIODS SHALL BE CONCLUSIVE EVIDENCE THAT THE MERCHANDISE SHIPPED IS SATISFACTORY IN ALL RESPECTS AND SUPPLIED IN ACCORDANCE WITH ORDERED SPECIFICATIONS.

LIMITATION OF LIABILITY: (a) SELLER DOES NOT UNDER ANY CIRCUMSTANCES, WHETHER AS A RESULT OF BREACH OF CONTRACT, BREACH OF WARRANTY, TORT OR OTHERWISE BE LIABLE FOR CONSEQUENTIAL, INCIDENTAL, SPECIAL OR EXEMPLARY DAMAGES, including, but not limited to, loss of profits or revenues, loss of use of or damage to any associated equipment, cost of capital, cost of substitute products, facilities or services, downtime costs, or claims of Buyer's customers. (b) SELLER'S LIABILITY ON ANY CLAIM OF ANY KIND FOR ANY LOSS OF DAMAGE ARISING OUT OF, RESULTING FROM, OR CONCERNING ANY ASPECT OF THIS AGREEMENT OR FROM THE PRODUCTS OR SERVICES FURNISHED HEREUNDER SHALL NOT EXCEED THE PRICE OF THE SPECIFIC ORDER OR SHIPMENT WHICH GIVES RISE TO THE CLAIM.

Notice Regarding Damage

These units were carefully packed in compliance with carrier regulations and thoroughly inspected before leaving our delivery plant. Responsibility for their safe delivery was assumed by the carrier upon acceptance of the shipment. Claims for loss or damage sustained in transit must, therefore, be made upon the carrier.

Concealed Loss or Damage

Concealed loss or damage means loss or damage which does not become apparent until the merchandise has been unpacked. The contents may be damaged in transit due to rough handling even though the package may not show external damage. When damage is discovered upon unpacking, make a request for inspection by the carrier's agent. Then file a claim with the carrier since such damage is the carrier's responsibility.

Visible Loss or Damage

Any external evidence of loss or damage must be noted on the freight bill or express receipt and signed by the carrier's agent. Failure to properly describe evidence of loss or damage may result in the carrier refusing to honor a claim. We definitely are not responsible for any damage incurred while merchandise is in transit. The transportation company will settle promptly all claims as they are insured and their rates cover this cost. Any correspondence in regard to loss or damage must be accompanied by a copy of the carrier's report.